

FLEX

Modular solution for embedded applications

version: 1.0.2
December 11, 2012



About Evidence S.r.l.

Evidence is a spin-off company of the ReTiS Lab of the Scuola Superiore S. Anna, Pisa, Italy. We are experts in the domain of embedded and real-time systems with a deep knowledge of the design and specification of embedded SW. We provide embedded firmware based on the Erika Enterprise RTOS for small single and multicore microcontrollers, custom Embedded Linux distributions for dedicated hardware, and a configuration and schedulability analysis tool named RT-Druid.

Evidence Contact Info

Address:

Evidence Srl,

Via Carducci 56

Località Ghezzano

56010 S.Giuliano Terme

Pisa - Italy

Tel: +39 050 991 1122, +39 050 991 1224

Fax: +39 050 991 0812, +39 050 991 0855

For more information on Evidence Products, please send an e-mail to the following address: info@evidence.eu.com. Other informations about the Evidence product line can be found at the Evidence web site at: <http://www.evidence.eu.com>.

About Embedded Solutions S.r.l.

Embedded Solutions is an Italian company specialized in hardware and software design. Embedded Solutions develops electronic devices based on microprocessor and microcontroller architectures, and it offers the possibility of having not only the hardware and software design of a product, but also the prototyping of multilayer boards with SMT and PTH technologies. The application fields covered by Embedded solutions starts from small applications with 8 bit microcontrollers, up to complex applications involving 32 bit general purpose microprocessors.

Embedded Solutions Contact Info

Address:

Embedded Solutions Srl

Via Piave, 14

20020 COGLIATE (MI), Italy

Tel: +39 02 96460455

Fax: +39 02 96468648

For more information on Embedded Solutions Products, please send an e-mail to the following address: info@es-online.it. Other informations about the Embedded Solutions product line can be found at the Embedded Solutions web site at: <http://www.es-online.it>.



This document is Copyright 2005-2012 Evidence S.r.l. and Embedded Solutions S.r.l.

Information and images contained within this document are copyright and the property of Evidence S.r.l. and Embedded Solutions S.r.l. All trademarks are hereby acknowledged to be the properties of their respective owners. The information, text and graphics contained in this document are provided for information purposes only by Evidence S.r.l. and Embedded Solutions S.r.l. Evidence S.r.l. and Embedded Solutions S.r.l. do not warrant the accuracy, or completeness of the information, text, and other items contained in this document. Matlab, Simulink, Mathworks are registered trademarks of Matworks Inc. Microsoft, Windows are registered trademarks of Microsoft Inc. Java is a registered trademark of Sun Microsystems. OSEK is a registered trademark of Siemens AG. The Microchip Name and Logo, and Microchip In Control are registered trademarks or trademarks of Microchip Technology Inc. in the USA. and other countries, and are used under license. All other trademarks used are properties of their respective owners. This document has been written using LaTeX and LyX.

Contents

1	About this Document	9
1.1	Purpose of this Document	9
1.2	History of this Document	10
2	Introduction	11
3	FLEX Hardware	13
3.1	Architecture	13
3.2	Base Boards	14
3.2.1	[FLEX001] FLEX Light Base Board	16
3.2.1.1	Technical details	17
3.2.2	[FLEX003] FLEX Full Base Board	21
3.2.2.1	Technical details	22
3.3	Daughter boards	27
3.3.1	[FLEX100] FLEX Thru Hole Daughter Board	27
3.3.1.1	Technical details	28
3.3.2	[FLEX101] FLEX Multibus Base Daughter Board	29
3.3.2.1	Technical details	30
3.3.3	[FLEX102] FLEX Multibus Ethernet Module	35
3.3.3.1	Technical details	35
3.3.4	[FLEX103] FLEX Multibus RS232 Module	37
3.3.4.1	Technical details	37
3.3.5	[FLEX104] FLEX Multibus RS485 Module	39
3.3.5.1	Technical details	39
3.3.6	[FLEX105] FLEX Multibus RS422 Module	41
3.3.6.1	Technical details	41
3.3.7	[FLEX106] FLEX Multibus CAN Module	43
3.3.7.1	Technical details	43
3.3.8	[FLEX107] FLEX Multibus SPI Module	45
3.3.8.1	Technical details	45
3.3.9	[FLEX108] FLEX Multibus Serial TTL Module	47
3.3.9.1	Technical details	47
3.3.10	Multibus I2C Module	49
3.3.11	[FLEX109] FLEX Demo Daughter Board	50
3.3.11.1	Technical details	52
3.4	Packs	57
3.4.1	[FLEX110] FLEX multibus pack	57

3.4.1.1	Technical details	58
3.4.2	[FLEX111] FLEX fast track suite	59
3.4.2.1	Technical details	60
3.5	Hardware Customisation	61
4	Software for FLEX	62
4.1	Erika Enterprise	62
4.2	Libraries for FLEX	62
4.3	Template applications	62
4.4	Scilab and Scicos code generator	63
5	FLEX Producers and Distributors	64
5.1	FLEX Producers	64
5.2	FLEX Distributors	65
5.2.1	Where is FLEX available?	65
5.2.2	What if my country is not listed?	65
5.2.3	Would you like to become a distributor?	66

List of Figures

2.1	FLEX logo	11
3.1	Piggybacking of FLEX Boards	13
3.2	FLEX Base Boards	14
3.3	[FLEX001] FLEX Light Base Board	16
3.4	[FLEX001] Dimensions of FLEX Light Base Board	17
3.5	[FLEX001] Details of FLEX Light Base Board	18
3.6	[FLEX003] FLEX Full Base Board	21
3.7	[FLEX003] Dimensions of FLEX Full Base Board	22
3.8	[FLEX003] Details of FLEX Full Base Board	23
3.9	[FLEX003] Jumper settings for programming PIC18	25
3.10	[FLEX003] Jumper settings for programming dsPIC	26
3.11	[FLEX100] FLEX Thru Hole Daughter Board	27
3.12	[FLEX101] FLEX Multibus Base Daughter Board	29
3.13	[FLEX101] Dimensions of FLEX Multibus Base Daughter Board	31
3.14	[FLEX101] Details of FLEX Multibus Base Daughter Board	32
3.15	[FLEX101] SPI Chip Select (Slot6) Jumper Settings	34
3.16	[FLEX102] FLEX Multibus Ethernet Module	35
3.17	[FLEX102] Details of FLEX Multibus Ethernet Module	35
3.18	[FLEX103] FLEX Multibus RS232 Module	37
3.19	[FLEX103] Details of FLEX Multibus RS232 Module	37
3.20	[FLEX104] FLEX Multibus RS485 Module	39
3.21	[FLEX104] Details of FLEX Multibus RS485 Module	39
3.22	[FLEX105] FLEX Multibus RS422 Module	41
3.23	[FLEX105] Details of FLEX Multibus RS422 Module	41
3.24	[FLEX106] FLEX Multibus CAN Module	43
3.25	[FLEX106] Details of FLEX Multibus CAN Module	43
3.26	[FLEX107] FLEX Multibus SPI Module	45
3.27	[FLEX107] Details of FLEX Multibus SPI Module	45
3.28	[FLEX108] FLEX Multibus Serial TTL Module	47
3.29	[FLEX108] Details of FLEX Multibus Serial TTL Module	47
3.30	[FLEX109] FLEX Demo Daughter Board - front side	50
3.31	[FLEX109] FLEX Demo Daughter Board - back side	51
3.32	[FLEX109] Dimensions of FLEX Demo Daughter Board	52
3.33	[FLEX109] Details of FLEX Demo Daughter Board	53
3.34	[FLEX110] FLEX multibus pack	57
3.35	[FLEX111] FLEX fast track suite	59

List of Tables

1.1	Versions of this document	10
3.1	FLEX Full Vs FLEX Light	15
3.2	FLEX001 - MORS1 (7-12 V power supply)	17
3.3	FLEX001 - LEDs	18
3.4	FLEX001 - Jumpers	18
3.5	FLEX001/FLEX003 - CON5 for Piggybacking	19
3.6	FLEX001/FLEX003 - CON6 for Piggybacking	20
3.7	FLEX001 - Other Connectors	20
3.8	FLEX003 - MORS1 (9-36 V power supply)	23
3.9	FLEX003 - LEDs	23
3.10	FLEX003 - Jumpers	24
3.11	FLEX003 - CON3 for Piggybacking (PIC18F2550)	24
3.12	FLEX003 - Other Connectors	24
3.13	FLEX003 - Jumper settings for programming PIC18	25
3.14	FLEX003 - Jumper settings for programming dsPIC	26
3.15	FLEX100 - Standard Connectors for Piggybacking	28
3.16	FLEX100 - Standard Pinhole Patterns	28
3.17	FLEX101 - MORS1 (RS232 module)	30
3.18	FLEX101 - MORS2 (CAN1 module)	30
3.19	FLEX101 - MORS3 (RS485 module)	31
3.20	FLEX101 - MORS4 (CAN2 module)	31
3.21	FLEX101 - MORS5 (I2C module)	31
3.22	FLEX101 - MORS6 (SPI module)	32
3.23	FLEX101 - Jumpers	33
3.24	FLEX101 - Other Connectors	33
3.25	FLEX101 - Slot Allocation	33
3.26	FLEX101 - SPI Chip Select (Slot6) Jumper Settings	33
3.27	FLEX102 - CON1	36
3.28	FLEX102 - CON2	36
3.29	FLEX103 - CON2	37
3.30	FLEX103 - CON3	38
3.31	FLEX104 - Jumpers	39
3.32	FLEX104 - CON1	40
3.33	FLEX104 - CON3	40
3.34	FLEX105 - Jumpers	41
3.35	FLEX105 - CON1	42

3.36	FLEX105 - CON2	42
3.37	FLEX106 - Jumpers	43
3.38	FLEX106 - CON1	44
3.39	FLEX106 - CON3	44
3.40	FLEX107 - Jumpers	45
3.41	FLEX107 - CON2	46
3.42	FLEX107 - CON3	46
3.43	FLEX108 - Jumpers	47
3.44	FLEX108 - CON2	48
3.45	FLEX108 - CON3	48
3.46	FLEX109 - MORS1 (DAC Connector)	53
3.47	FLEX109 - MORS2 (AUX Connector)	53
3.48	FLEX109 - MORS3 (UART Connector)	54
3.49	FLEX109 - LEDs	54
3.50	FLEX109 - Jumpers	54
3.51	FLEX109 - Push Buttons	54
3.52	FLEX109 - CON3+CON4 (ZigBee Connector)	55
3.53	FLEX109 - CON6 (Connected to Serial TTL)	55
3.54	FLEX109 - CON7 (connected to MORS3)	55
3.55	FLEX109 - CON8 (AUX2 Connector)	55
3.56	FLEX109 - CON9 (Power Connector)	56
5.1	FLEX Distributors	65

1 About this Document

This document is the reference manual for FLEX Boards.

1.1 Purpose of this Document

The purpose of this document is to act as a reference manual for users of Evidence srl's FLEX Boards.

1.2 History of this Document

Version	Date	Author	Change Description
0.10	-	Paolo Gai	Initial revision.
0.20	-	Paolo Gai	Re-style of sections sequence and partition. Added new pictures and content. Added tables about LEDs and jumpers.
0.21	-	Paolo Gai	Corrected some typos. Started section about the Thru Hole board. Updated style to include the Embedded Solutions logo. Added description to jumpers of the Light board.
0.22	-	Paolo Gai	Splitted app-notes.tex from the main content file. Added new picture about the piggybacking architecture.
0.23	-	Paolo Gai	New pictures for the latest FLEX boards.
0.25	-	Paolo Gai	Updated pictures of Thru Hole board and comparison between Base boards.
0.26	-	Paolo Gai	Updated ES logos. Updated typos, and added How to buy section.
0.27	-	Paolo Gai	Typos.
0.28	-	Paolo Gai	Typos. Added multibus section, added USA distributors.
0.29	-	Paolo Gai	Added rear photos of FLEX light and full. Added South America distributor.
0.30	-	Paolo Gai	Added mechanical description, added pinout mapping.
1.00	24/09/2008	Shiva	First Revision.
1.01	26/10/2008	Paolo Gai	Revision of the software chapter.
1.02	20/02/2009	Shiva	Added images of jumper settings on FLEX Full Base Board for dsPIC and PIC18 programming.

Table 1.1: Versions of this document

2 Introduction



Figure 2.1: FLEX logo

FLEX is an embedded board which can be used by developers who intend to exploit the full potential of the latest Microchip micro-controllers of the dsPIC® DSC family.

FLEX is born as a development board to develop and test real-time applications with ease for the Microchip dsPIC® DSC micro-controller.

The main features of FLEX are:

- Robust electronic design
- Modular architecture
- Availability of a growing number of application notes
- Availability of a code generator which is able to generate C code from a Scilab/Scicos design, and
- The full support of the Erika Enterprise real-time kernel from Evidence Srl

The compact design of FLEX makes it suitable not only for development, but also for direct deployment in the work environment like:

- Protocol converters
- Minimal web servers
- Acquisition systems

- Wireless systems
- Digital control systems

3 FLEX Hardware

3.1 Architecture

The modular architecture provided by FLEX allows to compound a number of boards to integrate different features into a single device.

The basic configuration of a FLEX device is made by the main board only. The FLEX Base Board, refer Figure 3.2, mounts a Microchip dsPIC® DSC micro-controller, and exports almost all the pins of the micro-controller. To build a specific application, the user can easily connect the desired components to the dsPIC® DSC ports.

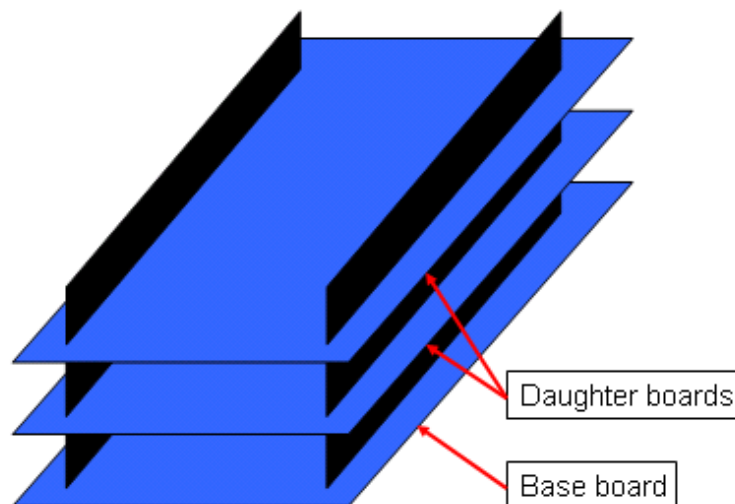

Figure 3.1: Piggybacking of FLEX Boards

As depicted in the Figure 3.1, several Daughter Boards, refer Section 3.3, can be connected in piggyback fashion to the FLEX Base Board, refer Section 3.2. The Daughter Boards have different features and they can be easily combined to obtain complex devices, refer Section 3.4. Evidence Srl and Embedded Solutions supply a growing number of Daughter Boards for basic and advanced applications.

3.2 Base Boards

The FLEX Base Boards are designed to export all the connections of a standard Microchip dsPIC® DSC micro-controller. The board connections use the standard 2.54mm pitch; this feature make it easy the usage of customised (by Evidence) or home-made Daughter Boards.

The dsPIC® DSC micro-controllers can be mounted on boards in two different ways:

1. by soldering the micro-controller directly on the surface of the board, or
2. by using a socket for installing the micro-controller through the interchangeable Plug-In Modules (PIMs) available from Microchip.

With the later, the developer need not worry about the number of programming cycles during the implementation/test/debugging phases, as once the limit is reached, a new PIM can be installed on the socket replacing the older one.

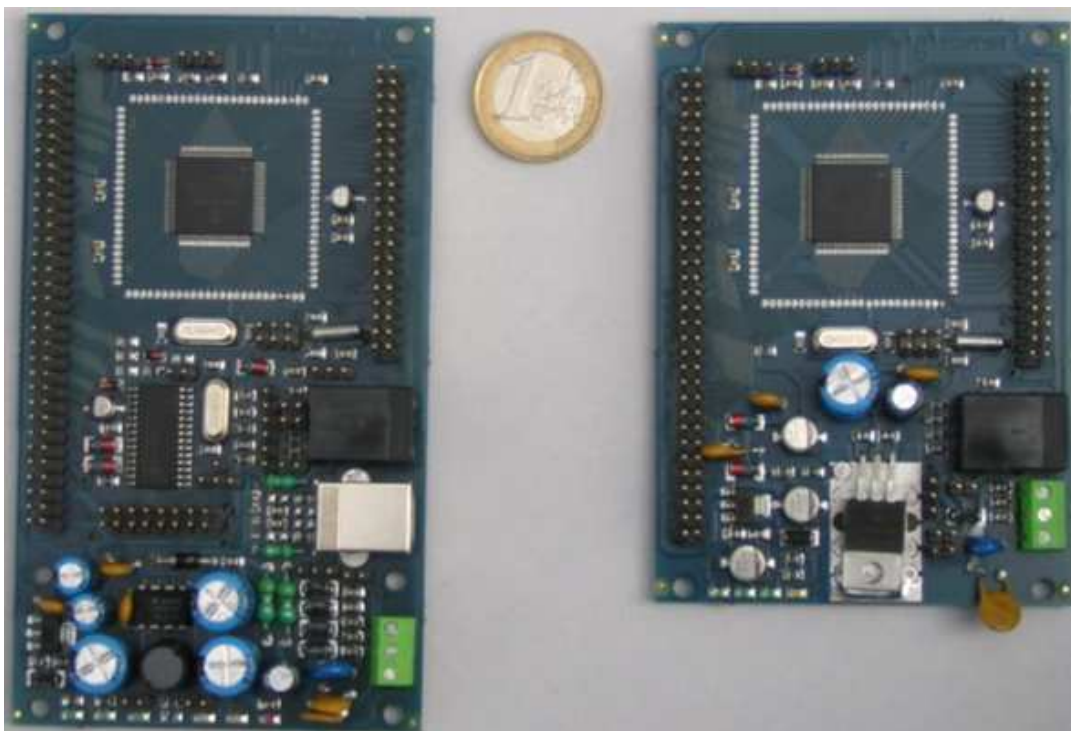

Figure 3.2: FLEX Base Boards

As depicted in Figure 3.2, The FLEX Base Board is available in two versions:

1. Light version, refer Subsection [3.2.1](#)
2. Full version, refer Subsection [3.2.2](#)

The connectors of the Full and Light Versions are fully compatible, so that an application developed with the Full Version can be easily moved to the Light Version and vice-versa (i.e. with fewer or no modification to the control program).

Safety has been one of the most important aspect considered while engineering both versions of FLEX. Both the Base Boards are protected by a resettable fuse, permitting longer duration of the board, even when used by non-highly-skilled users (i.e. in school laboratories for students experiments).

Table [3.1](#) compares FLEX Full with FLEX Light.

Features	Full	Light
Microchip dsPIC® DSC microcontroller dsPIC33FJ256MC710	•	•
Microchip PIC18® PIC18F2550 microcontroller for USB connection (programming using the USB port would be made available very soon)	•	
ICD2 in-circuit program connector	•	•
USB connector for communication	•	
Set of LEDs for monitoring the board functioning status	•	•
Set of connectors for Daughter boards piggybacking	•	•
Power supply connectors	•	•
Power supply circuitry with resettable fuses	•	•
Simplified power supply (7 - 12V)		•
Extra-robust switching power supply (9 - 36V)	•	

Table 3.1: FLEX Full Vs FLEX Light

3.2.1 [FLEX001] FLEX Light Base Board

The FLEX Light, as depicted in Figure 3.3, has been designed to be as compact as possible. The Light Version uses a simplified power supply circuitry and there is no integrated USB programming capability. Target applications for the FLEX Light could be: distributed, battery-powered applications, like sensor networks; small robotic applications, i.e., for mobile robot control and sensor acquisition, etc.

The power supply of the FLEX Light varies in the range of 9 - 12V.

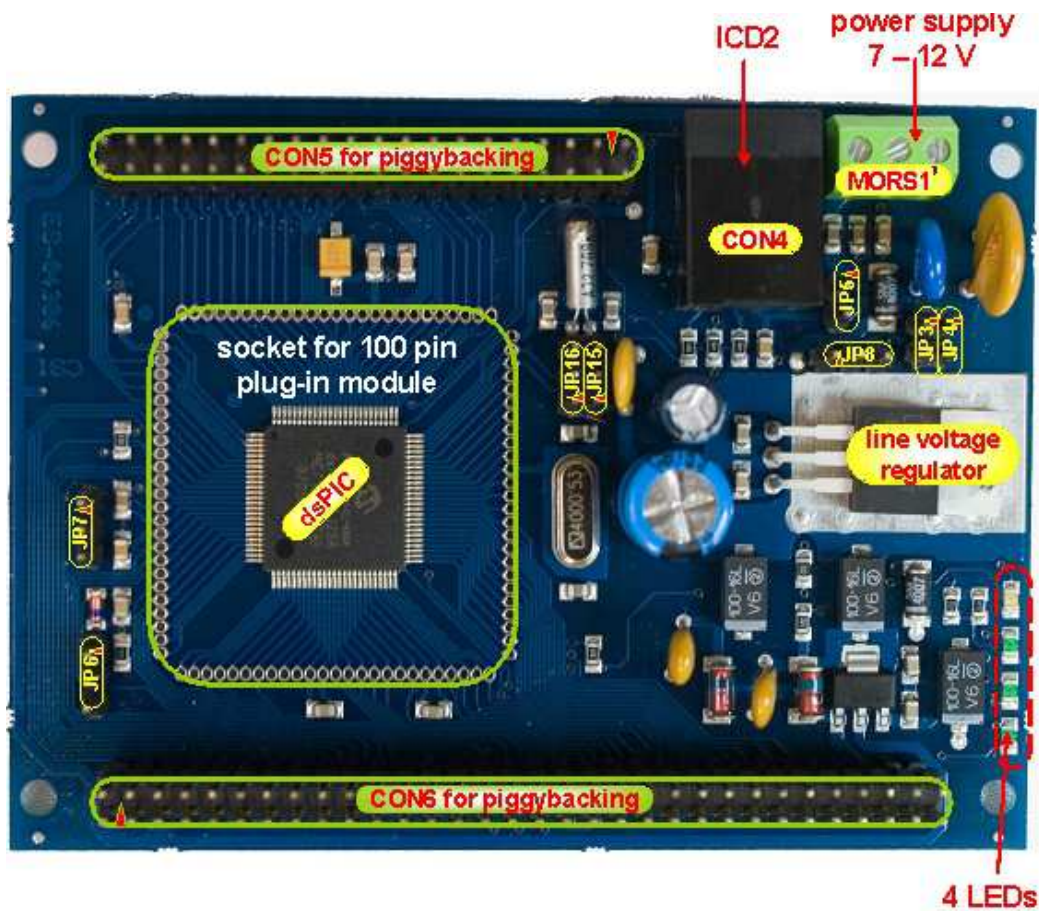

Figure 3.3: [FLEX001] FLEX Light Base Board

The main components of the FLEX Light are:

- Microchip dsPIC® DSC microcontroller dsPIC33FJ256MC710
- A socket for the 100 pin Plug-In Module (PIM) available from Microchip

- An ICD2 programmer connector
- Power supply connectors
- A set of LEDs for monitoring the board functioning status
- Set of connectors for Daughter boards piggybacking

3.2.1.1 Technical details

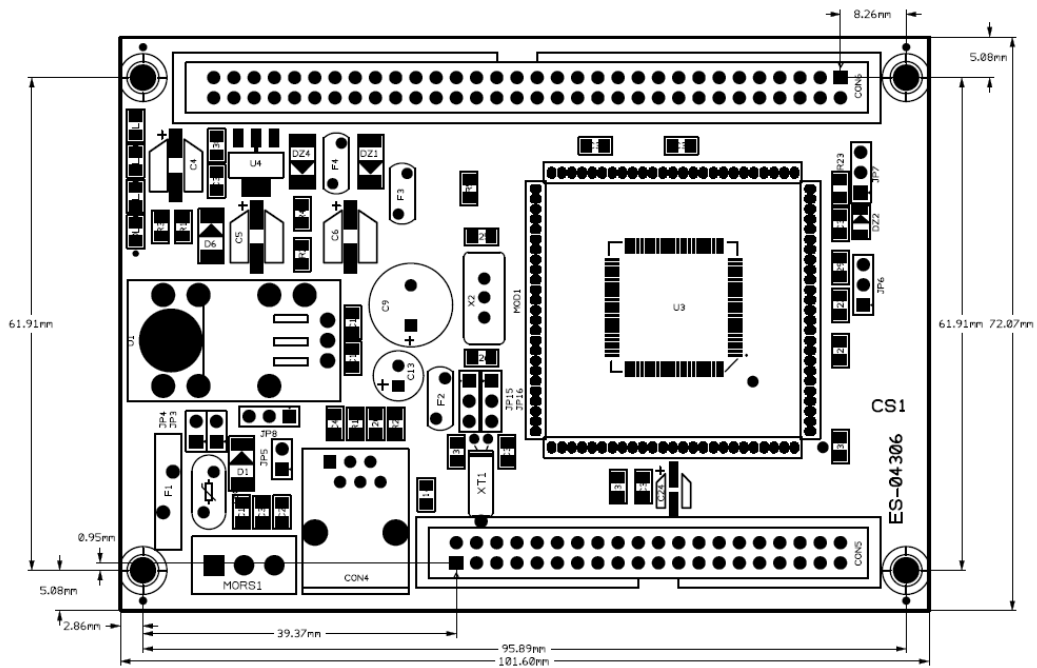

Figure 3.4: [FLEX001] Dimensions of FLEX Light Base Board

Pin 1	VIN
Pin 2	GND
Pin 3	EARTH

Table 3.2: FLEX001 - MORS1 (7-12 V power supply)

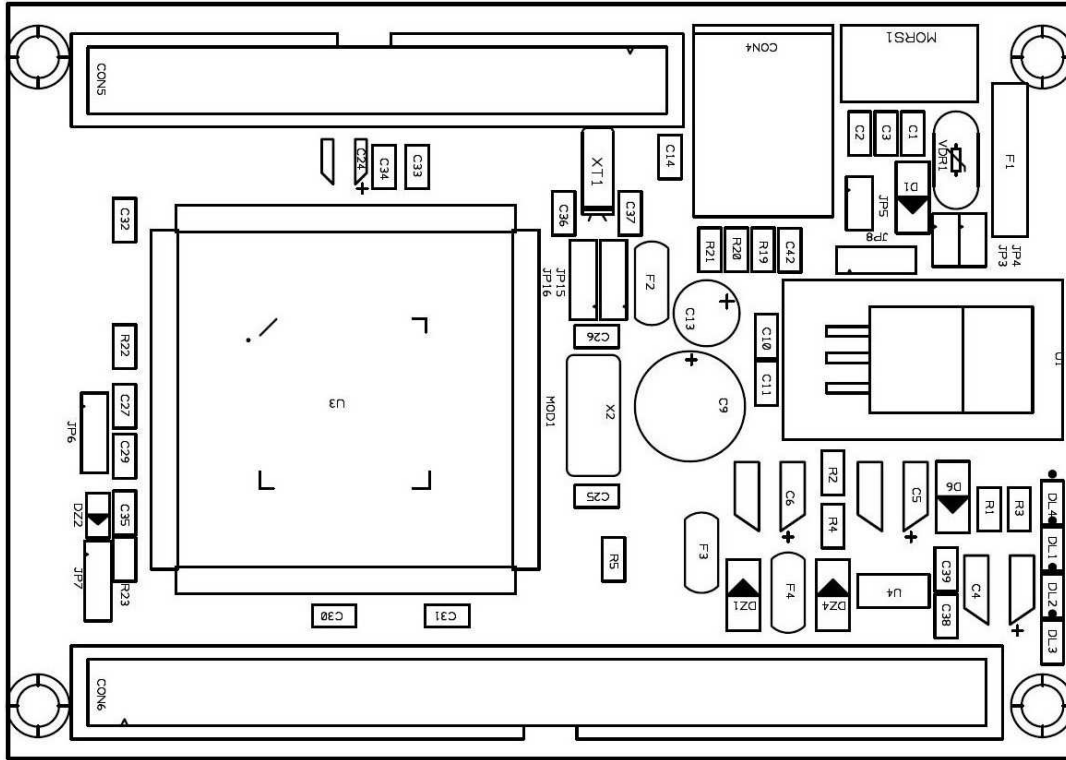

Figure 3.5: [FLEX001] Details of FLEX Light Base Board

DL1 (green)	Input power supply
DL2 (green)	Internal +5V power line activity
DL3 (green)	Internal +3V power line activity
DL4 (yellow)	dsPIC® DSC (e.g. for debugging)

Table 3.3: FLEX001 - LEDs

Jumper	pos. 1-2	pos. 2-3
JP3	● GND	-
JP4	● GND	-
JP5	● EARTH	-
JP6	● +3.3V	+AV DD _{ext}
JP7	● GND	AV SS _{ext}
JP8	+5V	● +3.3V
JP15	SOSCI	● CRYSTAL
JP16	SOSCO	● CRYSTAL

Note: Default jumper settings are indicated by a ●

Table 3.4: FLEX001 - Jumpers

Pin 1	V_{out}	Pin 2	$5V_{out}$
Pin 3	Gnd_{out}	Pin 4	$3V_{out}$
Pin 5	INT3/RA14	Pin 6	GND
Pin 7	IC1/RD8	Pin 8	INT4/RA15
Pin 9	IC3/RD10	Pin 10	IC2/RD9
Pin 11	OC1/RD0	Pin 12	IC4/RD11
Pin 13	OC3/RD2	Pin 14	OC2/RD1
Pin 15	IC5/RD12	Pin 16	OC4/RD3
Pin 17	OC5/CN13/RD4	Pin 18	IC6/CN19/RD13
Pin 19	OC7/CN15/RD6	Pin 20	OC6/CN14/RD5
Pin 21	C1RX/RF0	Pin 22	OC8/UPDNCN16/RD7
Pin 23	C2TX/RG1	Pin 24	C1TX/RF1
Pin 25	AN22/CN22/RA6	Pin 26	C2RX/RG0
Pin 27	PWM1L/RE0	Pin 28	AN23/CN23/RA7
Pin 29	CSCK/RG14	Pin 30	PWM1H/RE1
Pin 31	CSD0/RG13	Pin 32	CSDI/RG12
Pin 33	PWM2H/RE3	Pin 34	PWM2L/RE2
Pin 35	COFS/RG15	Pin 36	PWM3L/RE4
Pin 37	PWM4L/RE6	Pin 38	PWM3H/RE5
Pin 39	AN16/T2CK/T7CK/RC1	Pin 40	PWM4H/RE7

Table 3.5: FLEX001/FLEX003 - CON5 for Piggybacking

Pin 1	GND	Pin 2	GND
Pin 3	GND	Pin 4	GND
Pin 5	PGD2/EMUD2/SOSCI/CN1/RC13	Pin 6	PGC2/EMUC2/SOSCO/TICK/CN0/RC14
Pin 7	AN17/T3CK/T6CK/RC2	Pin 8	AN18/T4CK/T9CK/RC3
Pin 9	AN19/T5CK/T8CK/RC4	Pin 10	SCK2/CN8/RG6
Pin 11	SDI2/CN9/RG7	Pin 12	SDO2/CN10/RG8
Pin 13	DSP _{MCLR}	Pin 14	SS2/CN11/RG9
Pin 15	TMS/RA0	Pin 16	AN20/FLTA/INT1/RE8
Pin 17	AN21/FLTB/INT2/RE9	Pin 18	AN5/QEB/CN7/CN7/RB5
Pin 19	AN4/QEA/CN6/RB4	Pin 20	AN3/INDX/CN5/RB3
Pin 21	AN2/SS1/CN4/RB2	Pin 22	V _{ref-} /RA9
Pin 23	V _{ref+} /RA10	Pin 24	AV DD _{ext}
Pin 25	AV SS _{ext}	Pin 26	AN8/RB8
Pin 27	AN9/RB9	Pin 28	AN10/RB10
Pin 29	AN11/RB11	Pin 30	TCK/RA1
Pin 31	U2CTS/RF12	Pin 32	U2RTS/RF13
Pin 33	AN13/RB13	Pin 34	AN12/RB12
Pin 35	IC7/U1CTS/CN20/RD14	Pin 36	AN15/OCFB/CN12/RB15
Pin 37	U2RX/CN17/RF4	Pin 38	IC8/U1RTS/CN21/RD15
Pin 39	U1TX/RF3	Pin 40	U2TX/CN18/RF5
Pin 41	SDO1/RF8	Pin 42	U1RX/RF2
Pin 43	SCK1/INT0/RF6	Pin 44	SDI1/RF7
Pin 45	SCL1/RG2	Pin 46	SDA1/RG3
Pin 47	SDA2/RA3	Pin 48	SCL2/RA2
Pin 49	TD0/RA5	Pin 50	TDI/RA4
Pin 51	PGD3/EMUD3/AN0/CN2/RB0	Pin 52	DSP _{PCLK}
Pin 53	PGC3/EMUC3/AN1/CN3/RB1	Pin 54	DSP _{PDATA}
Pin 55	5V _{out}	Pin 56	5V _{out}
Pin 57	3V _{out}	Pin 58	3V _{out}
Pin 59	GND	Pin 60	GND
Pin 61	V _{out}	Pin 62	V _{out}
Pin 63	GND _{out}	Pin 64	GND _{out}

Table 3.6: FLEX001/FLEX003 - CON6 for Piggybacking

- CON4: ICD2 connector

Table 3.7: FLEX001 - Other Connectors

3.2.2 [FLEX003] FLEX Full Base Board

The FLEX Full, as depicted in Figure 3.6, integrates an extra-robust power supply circuitry, that allows usage of a wide range of power suppliers. It accepts voltage ranges between 9 - 36 volts. The power supply signal is filtered and adapted to the internal levels.

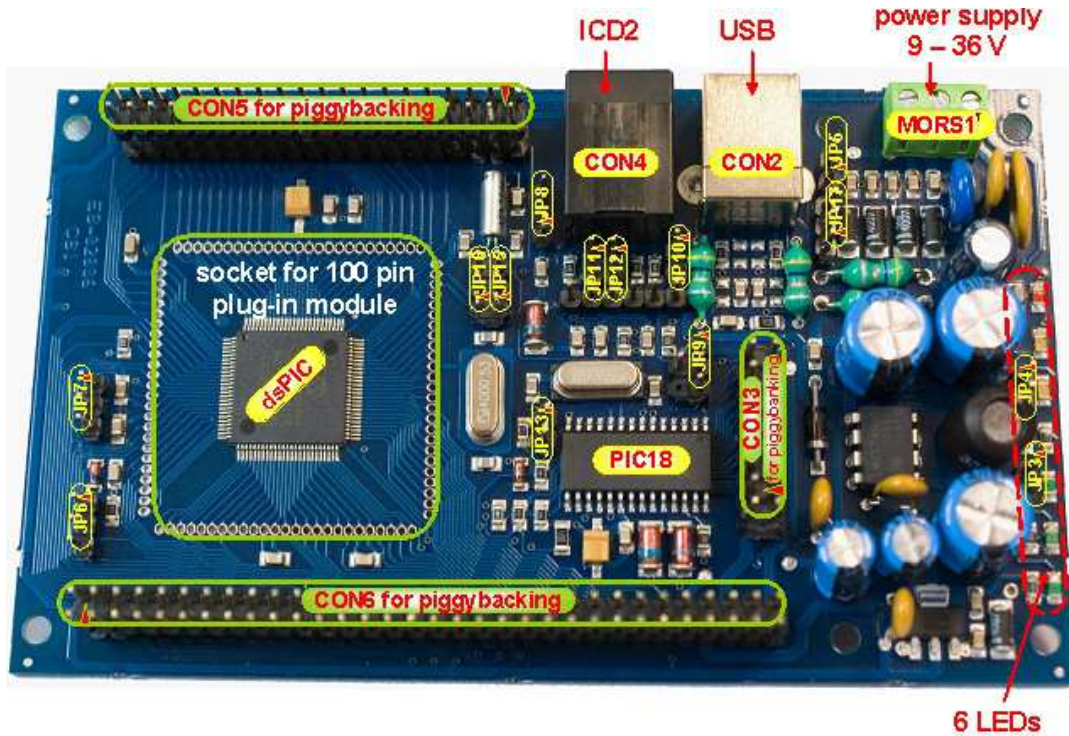

Figure 3.6: [FLEX003] FLEX Full Base Board

The FLEX Full also includes a native USB port which can be used for data transfer and, much more importantly as a programming interface for the onboard dsPIC® DSC. This option allows to save the cost of the ICD2 programming device, thereby making the development board fully self-contained.

Please note that the programming and debugging functionality on the PIC18 is not yet available. An application note will be available soon with all the needed information on how to implement the programmer functionality on the PIC18. The debugger functionality will be available as special version of the FLEX Full.

The main components of FLEX Full are:

- Microchip dsPIC® DSC microcontroller dsPIC33FJ256MC710
- A socket for the 100 pin Plug-In Module (PIM) available from Microchip
- An ICD2 programmer connector
- A USB connector for direct programming
- Power supply connectors
- A set of LEDs for monitoring the board functioning status
- An onboard Microchip PIC18® PIC18F2550 microcontroller for integrated programming
- Set of connectors for Daughter boards piggybacking

3.2.2.1 Technical details

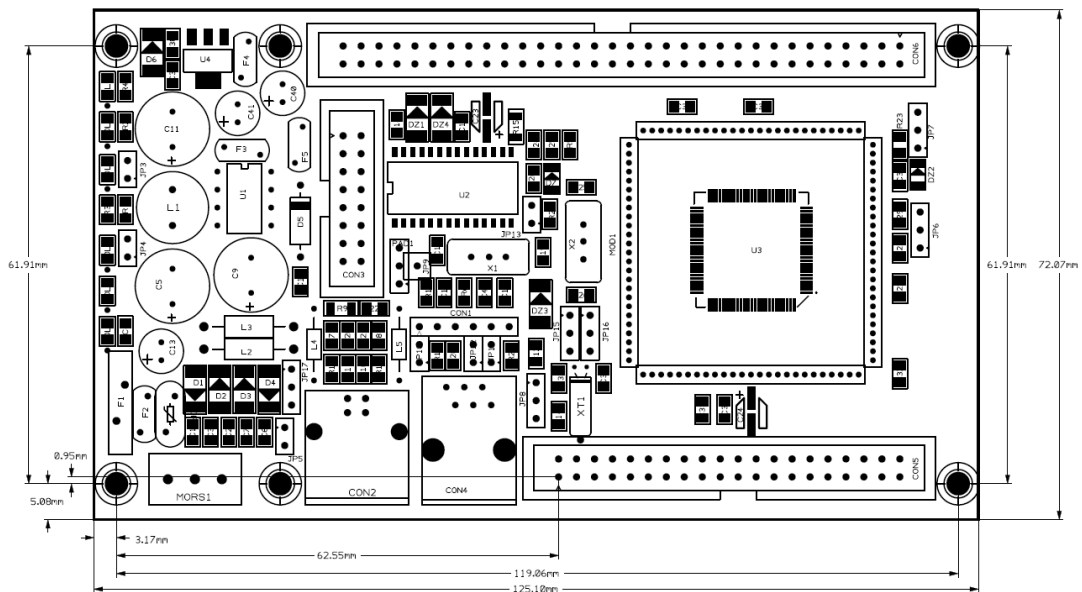

Figure 3.7: [FLEX003] Dimensions of FLEX Full Base Board

As a quick reference for jumper settings, figures 3.10 and 3.9 are meant for programming dsPIC and PIC18 respectively of the FLEX Full Base Board.

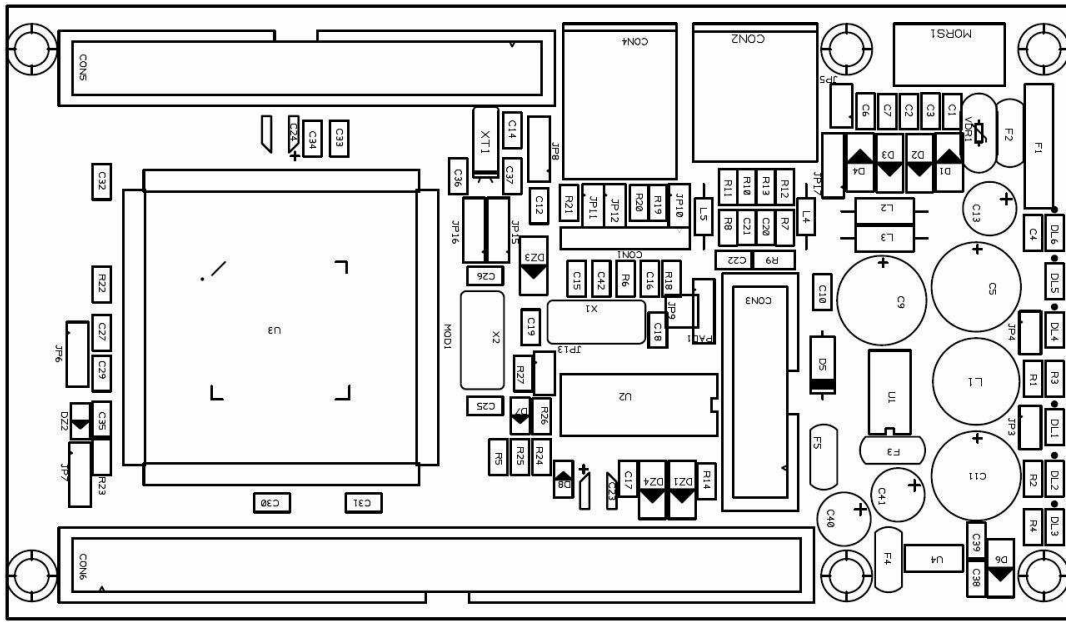

Figure 3.8: [FLEX003] Details of FLEX Full Base Board

Pin 1	VINA
Pin 2	VINB
Pin 3	EARTH

Table 3.8: FLEX003 - MORS1 (9-36 V power supply)

DL1 (green)	Input power supply
DL2 (green)	Internal +5V power line activity
DL3 (green)	Internal +3V power line activity
DL4 (yellow)	dsPIC® DSC (e.g. for debugging)
DL5 (yellow)	Internal PIC18
DL6 (red)	USB cable connection monitor

Table 3.9: FLEX003 - LEDs

Jumper	pos. 1-2	pos. 2-3
JP3	• GND	-
JP4	• GND	-
JP5	• EARTH	-
JP6	• +3.3V	+AV DD _{ext}
JP7	• GND	AV SS _{ext}
JP8	+5V	• +3.3V
JP9	+USB	• +5V
JP10	• DSP_MCLR	PIC18_MCLR
JP11	• DSP_PDATA	PIC18_PDATA
JP12	• DSP_PCLK	PIC18_PCLK
JP13	VDD pull up	-
JP15	SOSCI	• CRYSTAL
JP16	SOSCO	• CRYSTAL
JP17	• GND	EARTH

Note: Default jumper settings are indicated by a •

Table 3.10: FLEX003 - Jumpers

Pin 1	+VDD _{out}	Pin 2	GND
Pin 3	RA0/AN0	Pin 4	RB4/AN11/KB10
Pin 5	RA1/AN1	Pin 6	RB3/AN9/CCP2/VPO
Pin 7	RA2/AN2/V _{ref-} /CV _{ref}	Pin 8	RC7/RX/DT/SDO
Pin 9	RA3/AN3/Vref+	Pin 10	RC6/TX/CK
Pin 11	RA5/AN4/HLVDin/C2 _{out}	Pin 12	RC2/CCP1
Pin 13	RC1/T1OSI/CCP2/UOE#	Pin 14	RA4/T0CKI/C1 _{out} /RCV
Pin 15	L _{MCLR}	Pin 16	RC0/T1OSO/T1CKI

Table 3.11: FLEX003 - CON3 for Piggybacking (PIC18F2550)

- | |
|---|
| <ul style="list-style-type: none"> • CON2: USB connector • CON4: ICD2 connector • CON5: 40 pin piggybacking connector, refer Table 3.5 • CON6: 64 pin piggybacking connector, refer Table 3.6 |
|---|

Table 3.12: FLEX003 - Other Connectors

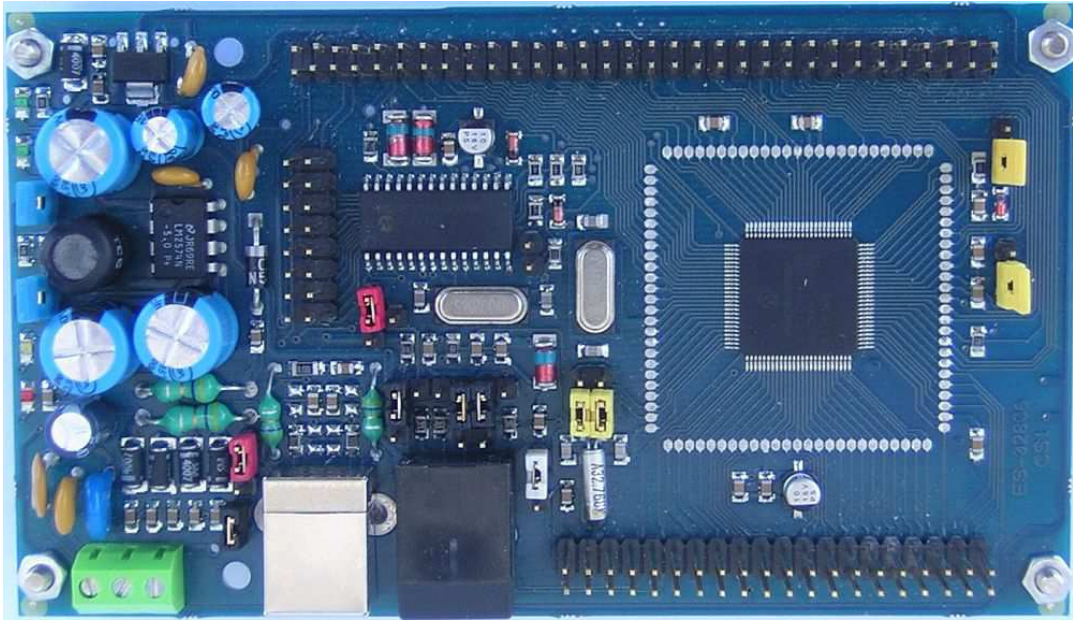

Figure 3.9: [FLEX003] Jumper settings for programming PIC18

Jumper	pos. 1-2	pos. 2-3
JP3	•	-
JP4	•	-
JP5	•	-
JP6	•	
JP7	•	
JP8	•	
JP9		•
JP10		•
JP11		•
JP12		•
JP13		-
JP15		•
JP16		•
JP17	•	

Table 3.13: FLEX003 - Jumper settings for programming PIC18

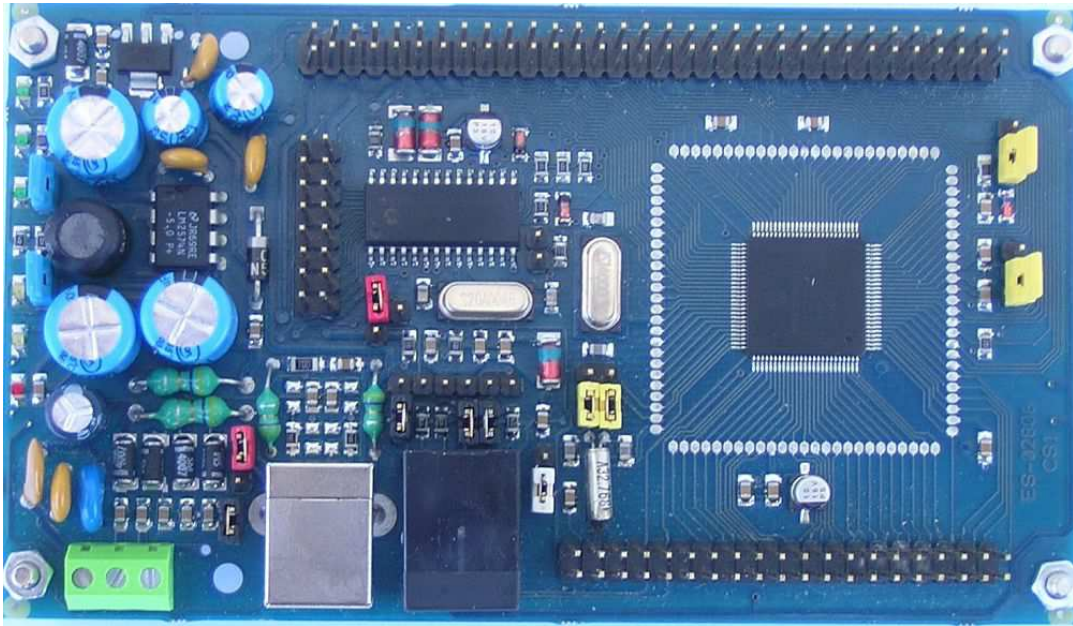

Figure 3.10: [FLEX003] Jumper settings for programming dsPIC

Jumper	pos. 1-2	pos. 2-3
JP3	●	-
JP4	●	-
JP5	●	-
JP6	●	
JP7	●	
JP8	●	
JP9		●
JP10	●	
JP11	●	
JP12	●	
JP13		-
JP15		●
JP16		●
JP17	●	

Table 3.14: FLEX003 - Jumper settings for programming dsPIC

3.3 Daughter boards

A FLEX Daughter Board is a board with specialized features that can be added on top of a FLEX Base Board, refer Section 3.2 (by piggybacking, refer Figure 3.1), to obtain complex devices for all possible applications.

Evidence Srl and Embedded Solutions propose a set of general purpose Daughter Boards for some of the most common applications.

The development of customised, refer Section 3.5, or home-made Daughter Boards are made easy as the FLEX Base Board connectors uses the standard 2.54mm pitch. Hence, virtually, the extending of features of the FLEX platform, refer Table 3.1, is unlimited.

3.3.1 [FLEX100] FLEX Thru Hole Daughter Board

The board, depicted in Figure 3.11, is targeted for the development of small, homemade, custom circuits that can be transparently interfaced with the FLEX Base Boards, refer Figure 3.2.

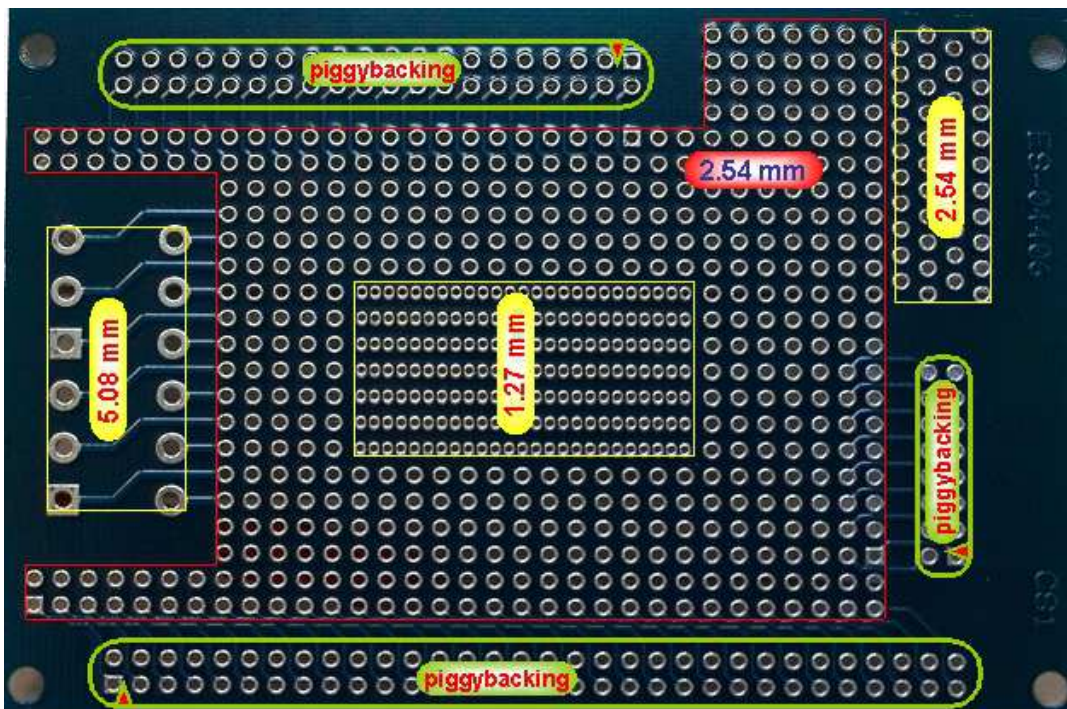

Figure 3.11: [FLEX100] FLEX Thru Hole Daughter Board

The board makes available to the user several common pinholes for connecting electronic components. Pinholes marked with "piggybacking" are pins which come from the piggybacked FLEX board, refer Figure 3.1, and each pin on the piggybacking row is connected to a pin on the most wide board section.

3.3.1.1 Technical details

- | |
|--|
| <ul style="list-style-type: none">• CON3: 16 pin connector, refer Table 3.11• CON5: 40 pin connector, refer Table 3.5• CON6: 64 pin connector, refer Table 3.6 |
|--|

Table 3.15: FLEX100 - Standard Connectors for Piggybacking

- | |
|---|
| <ul style="list-style-type: none">• 5.08 mm for clamps• 2.54 mm for RJ45, RS232, etc. connectors• 2.54 mm for all other components• 1.27 mm for typical SMD components |
|---|

Table 3.16: FLEX100 - Standard Pinhole Patterns

3.3.2 [FLEX101] FLEX Multibus Base Daughter Board

The FLEX Multibus Base Board, as depicted in Figure 3.12, is a FLEX Daughter Board, refer Section 3.3. It fits directly on FLEX Base Board (FLEX Full, refer Subsection 3.2.1/FLEX Light, refer Subsection 3.2.2), and number of slots, refer Table 3.25, are available for FLEX Multibus Modules to be mounted on top of it, thereby extending the FLEX platform.

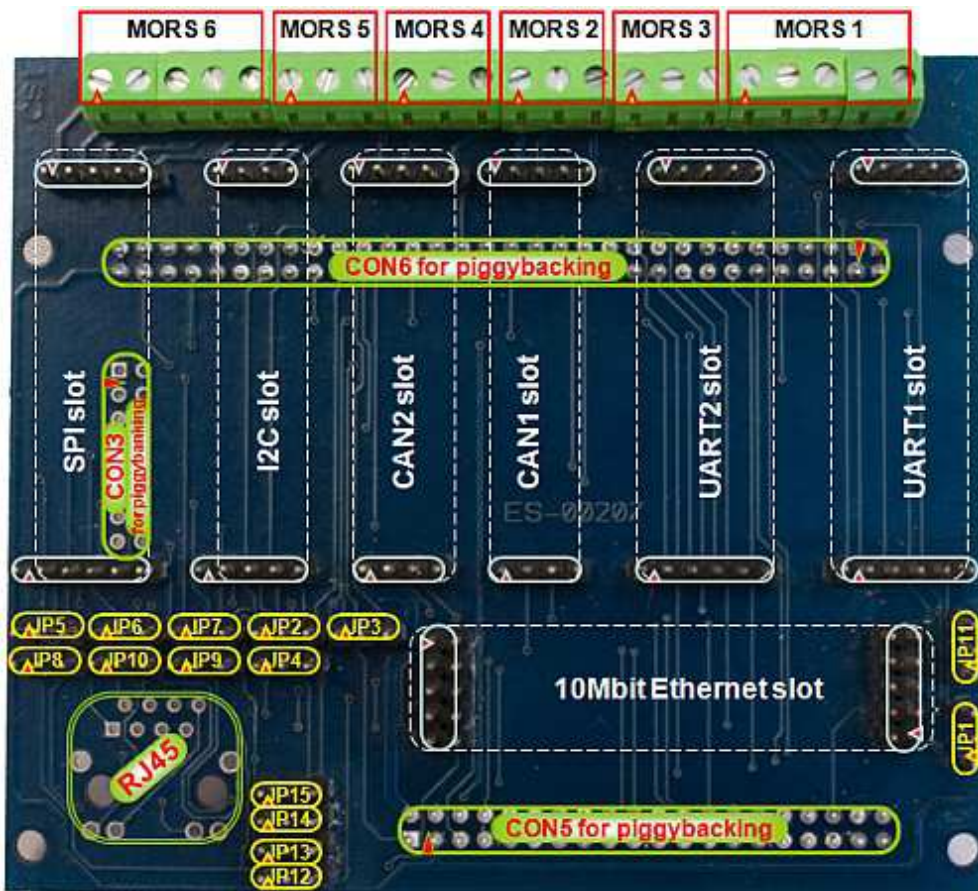

Figure 3.12: [FLEX101] FLEX Multibus Base Daughter Board

Note: The RJ45 Ethernet Connector is not included with this product. It is sold along with the FLEX Multibus Ethernet Module, refer Subsection 3.3.3, and has to be soldered on the FLEX Multibus Base Daughter Board.

The following slots are available on the Multibus board:

- UART2 slot, for Serial TTL/RS232/RS485/RS422 module
- UART1 slot, for Serial TTL/RS232/RS485 module
- CAN1 slot, for CAN module
- CAN2 slot, for CAN module
- I2C slot (channel selectable), for I2C module
- SPI slot (channel selectable), for SPI module
- Ethernet slot, for 10Mbit Ethernet module

Note: Modules are mounted only if needed. For example, if the application requires the Ethernet interface and the connection to the CAN bus, only the corresponding modules will be mounted on the Multibus Base Board, leaving the remaining pins free for other use.

Chip select of SPI Module (Slot 6): Jumpers JP8, JP9, and JP10 control the chip select of the SPI module from either a general purpose I/O or chip select pin built-in in the microcontroller, refer Figures 3.14 and 3.15 and Tables 3.23 and 3.26.

3.3.2.1 Technical details

Pin 1	CTS PC
Pin 2	RX PC
Pin 3	TX PC
Pin 4	RTS PC
Pin 5	GND

Table 3.17: FLEX101 - MORS1 (RS232 module)

Pin 1	O_CAN+
Pin 2	O_CAN-
Pin 3	GND

Table 3.18: FLEX101 - MORS2 (CAN1 module)

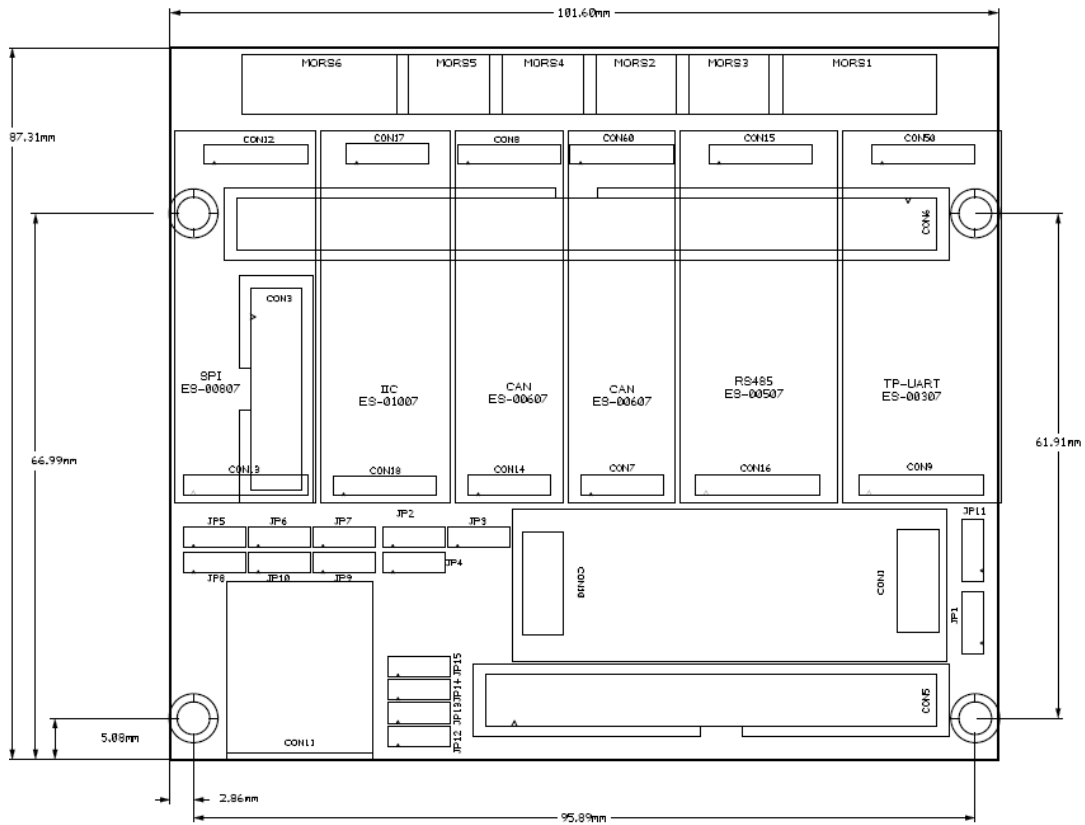

Figure 3.13: [FLEX101] Dimensions of FLEX Multibus Base Daughter Board

Pin 1	485-
Pin 2	485+
Pin 3	GND

Table 3.19: FLEX101 - MORS3 (RS485 module)

Pin 1	O_CAN+1
Pin 2	O_CAN-1
Pin 3	GND

Table 3.20: FLEX101 - MORS4 (CAN2 module)

Pin 1	IIC_DIO_C
Pin 2	IIC_CK_C
Pin 3	GND

Table 3.21: FLEX101 - MORS5 (I2C module)

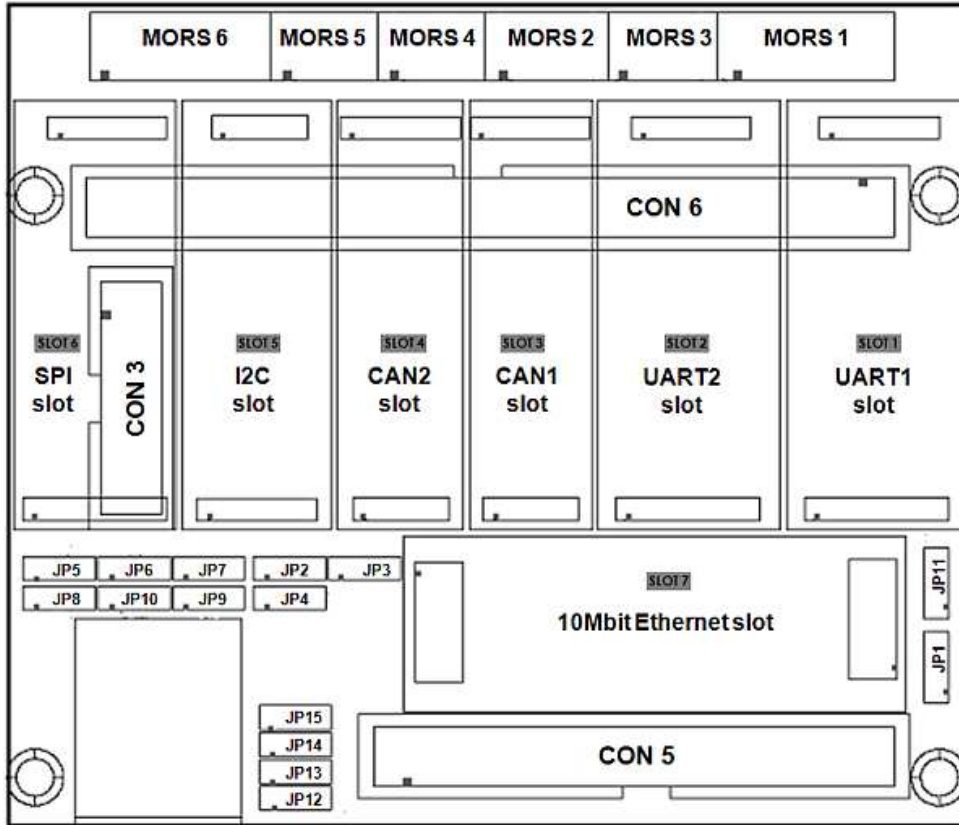

Figure 3.14: [FLEX101] Details of FLEX Multibus Base Daughter Board

Pin 1	SPI_DO_C
Pin 2	SPI_DI_C
Pin 3	SPI_CLK_C
Pin 4	SPI_SS_C
Pin 5	GND

Table 3.22: FLEX101 - MORS6 (SPI module)

Jumper	pos. 1-2	pos. 2-3
JP1	FRCK_1	RESN
JP2	IIC_2 DIO	IIC_1 DIO
JP3	IIC_2 CLK	IIC_1 CLK
JP4	IIC_2 CS	IIC_1 CS
JP5	SPI_2 DI	SPI_1 DI
JP6	SPI_2 DO	SPI_1 DO
JP7	SPI_2 CLK	SPI_1 CLK
JP8	SPI_1 SS_up	SPI_1 SS
JP9	SPI_2 SS JP8/JP10	SPI_1 SS JP8/JP9
JP10	SPI_2 SS_up	SPI_2 SS
JP11	GND	GND_OUT
JP12	LAN SPI_2 DI	LAN SPI_1 DI
JP13	LAN SPI_2 DO	LAN SPI_1 DO
JP14	LAN SPI_2 CLK	LAN SPI_1 CLK
JP15	LAN SPI_2 SS	LAN SPI_1 SS

Note: Default jumper settings are indicated by a •

Table 3.23: FLEX101 - Jumpers

- | |
|---|
| <ul style="list-style-type: none"> • CON3: 16 pin piggybacking connector, refer Table 3.11 • CON5: 40 pin piggybacking connector, refer Table 3.5 • CON6: 64 pin piggybacking connector, refer Table 3.6 |
|---|

Table 3.24: FLEX101 - Other Connectors

Module	Slot1	Slot2	Slot3	Slot4	Slot5	Slot6
RS232 (FLEX103)	•	•				
RS485 (FLEX104)	•	•				
RS422 (FLEX105)	•					
CAN (FLEX106)			•	•		
SPI (FLEX107)						•
Serial TTL (FLEX108)	•	•				
I2C					•	

Table 3.25: FLEX101 - Slot Allocation

JP8	JP9	JP10	Chip select from
	1-2	1-2	RB9
	1-2	2-3	SS2 (RG9)
1-2	2-3		RB8
2-3	2-3		SS1 (RB2)

Table 3.26: FLEX101 - SPI Chip Select (Slot6) Jumper Settings

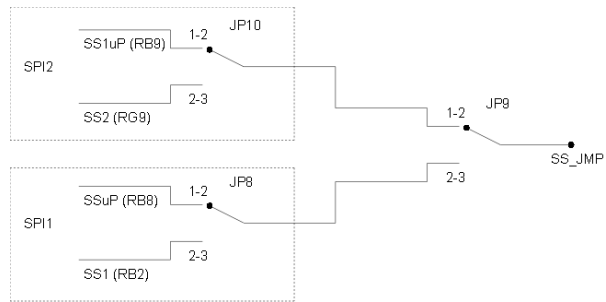

Figure 3.15: [FLEX101] SPI Chip Select (Slot6) Jumper Settings

Multibus Modules

The FLEX Multibus Modules are piggybacked on the FLEX Multibus Base Daughter Board, refer Subsection 3.3.2. These are the most widely used serial communication standards currently available:

3.3.3 [FLEX102] FLEX Multibus Ethernet Module

The board, depicted in Figure 3.16, is the Ethernet Module. It fits on slot 7 of the FLEX Multibus Base Daughter Board, refer Figure 3.14.

The module can be used to export an ethernet connection through the RJ45 connector available on the Multibus Base Board. The ethernet chip used is the Microchip ENC28J60, which is connected to the dsPIC® by using the SPI bus.



Figure 3.16: [FLEX102] FLEX Multibus Ethernet Module

Note: One RJ45 Ethernet Connector is included with this product. It is to be soldered on the FLEX Multibus Base Daughter Board, refer Figure 3.12.

3.3.3.1 Technical details

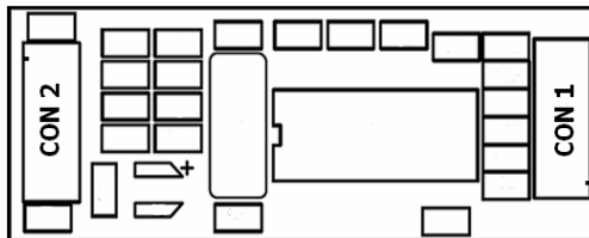

Figure 3.17: [FLEX102] Details of FLEX Multibus Ethernet Module

Pin 1	SDO_2	Pin 2	SCK_2
Pin 3	SDI_2	Pin 4	RE_4
Pin 5	SS_2	Pin 6	INT_4
Pin 7	CN_1	Pin 8	INT_3
Pin 9	GND	Pin 10	+3.3V

Table 3.27: FLEX102 - CON1

Pin 1	LED_A	Pin 2	TPOUT +3.3V
Pin 3	TPOUT-	Pin 4	TPOUT+
Pin 5	-	Pin 6	TPIN GND
Pin 7	TPIN-	Pin 8	TPIN+
Pin 9	LED_B	Pin 10	GND

Table 3.28: FLEX102 - CON2

3.3.4 [FLEX103] FLEX Multibus RS232 Module

The board, depicted in Figure 3.18, is the Rs232 Module. It fits on slot 1 and/or slot 2 of the FLEX Multibus Base Daughter Board, refer Figure 3.14.

This module can be used to export the UART pins linked to the UART peripherals on the dsPIC® by using signals which are compatible with the RS232 standard.

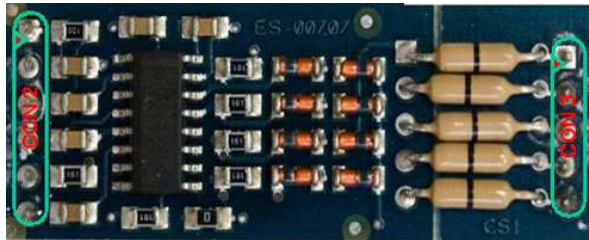

Figure 3.18: [FLEX103] FLEX Multibus RS232 Module

3.3.4.1 Technical details

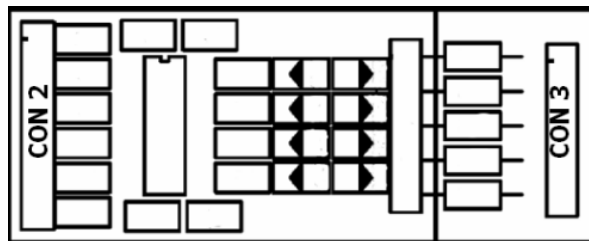

Figure 3.19: [FLEX103] Details of FLEX Multibus RS232 Module

Pin 1	+5V
Pin 2	TX_1
Pin 3	SCK_1
Pin 4	RX_1
Pin 5	FRCK_1
Pin 6	GND

Table 3.29: FLEX103 - CON2

Pin 1	CTS PC
Pin 2	RX PC
Pin 3	TX PC
Pin 4	RTS PC
Pin 5	GND

Table 3.30: FLEX103 - CON3

3.3.5 [FLEX104] FLEX Multibus RS485 Module

The board, depicted in Figure 3.20, is the RS485 Module. It fits on slot 1 and/or slot 2 of the FLEX Multibus Base Daughter Board, refer Figure 3.14.

This module can be used to export the UART pins linked to the UART peripherals on the dsPIC® by using signals which are compatible with the RS485 standard.

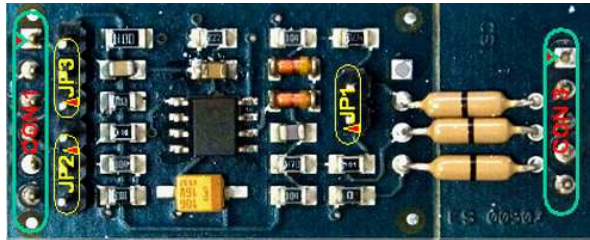

Figure 3.20: [FLEX104] FLEX Multibus RS485 Module

3.3.5.1 Technical details

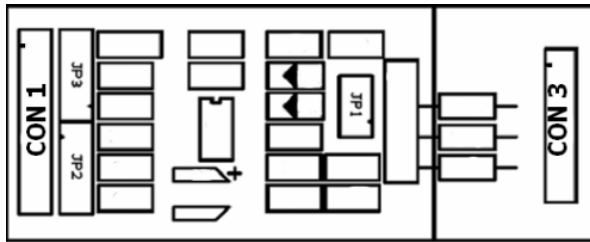

Figure 3.21: [FLEX104] Details of FLEX Multibus RS485 Module

Jumper	pos. 1-2	pos. 2-3
JP1	LOOPBACK	-
JP2	TXEN_dsPIC	TXEN_GND
JP3	TXEN_dsPIC	TXEN_+5V

Note: Default jumper settings are indicated by a ●

Table 3.31: FLEX104 - Jumpers

Pin 1	+5V
Pin 2	TX
Pin 3	TXEN
Pin 4	RX
Pin 5	-
Pin 6	GND

Table 3.32: FLEX104 - CON1

Pin 1	-
Pin 2	RS485-
Pin 3	RS485+
Pin 4	-
Pin 5	GND

Table 3.33: FLEX104 - CON3

3.3.6 [FLEX105] FLEX Multibus RS422 Module

The board, depicted in Figure 3.22, is the RS422 Module. It fits on slot 1 of the FLEX Multibus Base Daughter Board, refer Figure 3.14.

This module can be used to export the UART pins linked to the UART peripherals on the dsPIC® by using signals which are compatible with the RS422 specification.

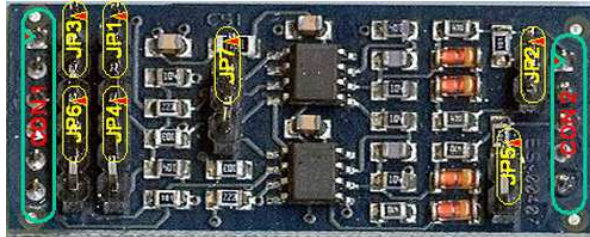

Figure 3.22: [FLEX105] FLEX Multibus RS422 Module

3.3.6.1 Technical details

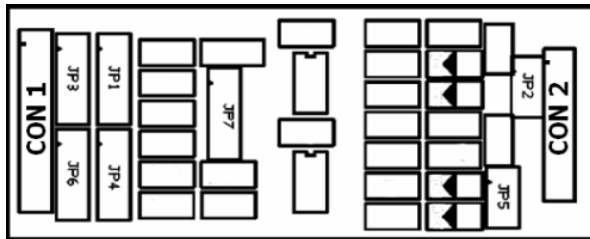

Figure 3.23: [FLEX105] Details of FLEX Multibus RS422 Module

Jumper	pos. 1-2	pos. 2-3
JP1	TXEN_dsPIC	TXEN +5V
JP2	LOOPBACK_0	-
JP3	TXEN_dsPIC	TXEN GND
JP4	TXEN_dsPIC	TXEN +5V
JP5	LOOPBACK_1	-
JP6	TXEN_dsPIC	TXEN GND
JP7	RX_0	RX_1

Note: Default jumper settings are indicated by a •

Table 3.34: FLEX105 - Jumpers

Pin 1	+5V
Pin 2	TX
Pin 3	TXEN
Pin 4	RX
Pin 5	-
Pin 6	GND

Table 3.35: FLEX105 - CON1

Pin 1	RS485+_0
Pin 2	RS485-_0
Pin 3	RS485+_1
Pin 4	RS485-_1
Pin 5	GND

Table 3.36: FLEX105 - CON2

3.3.7 [FLEX106] FLEX Multibus CAN Module

The board, depicted in Figure 3.24, is the CAN Module. It fits on slot 3 and/or slot 4 of the FLEX Multibus Base Daughter Board, refer Figure 3.14.

The module can be used to export the CAN peripheral pins which are available on the dsPIC® using a CAN transceiver.

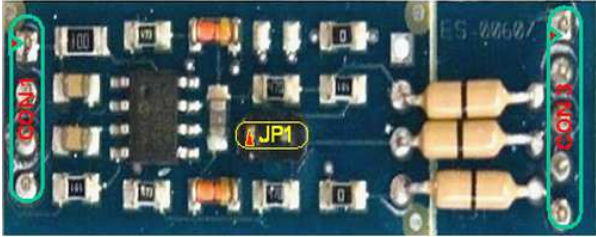

Figure 3.24: [FLEX106] FLEX Multibus CAN Module

3.3.7.1 Technical details

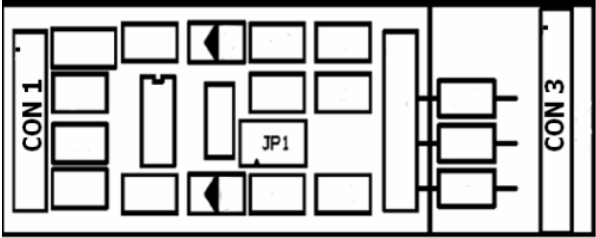

Figure 3.25: [FLEX106] Details of FLEX Multibus CAN Module

Jumper	pos. 1-2	pos. 2-3
JP1	LOOPBACK	-

Note: Default jumper settings are indicated by a •

Table 3.37: FLEX106 - Jumpers

Pin 1	+5V
Pin 2	RX_CAN
Pin 3	TX_CAN
Pin 4	GND

Table 3.38: FLEX106 - CON1

Pin 1	-
Pin 2	CAN+
Pin 3	CAN-
Pin 4	-
Pin 5	GND

Table 3.39: FLEX106 - CON3

3.3.8 [FLEX107] FLEX Multibus SPI Module

The board, depicted in Figure 3.26, is the SPI Module. It fits on slot 6 of the FLEX Multibus Base Daughter Board, refer Figure 3.14.

The module can be used to export one of the SPI peripheral pins which are available on the dsPIC®. The module also has a set of components which are used to protect the microcontroller pins from input signals that are not compatible with the specifications.

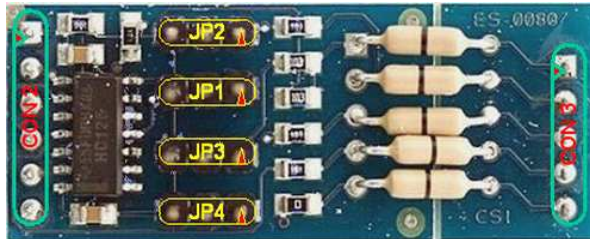

Figure 3.26: [FLEX107] FLEX Multibus SPI Module

3.3.8.1 Technical details

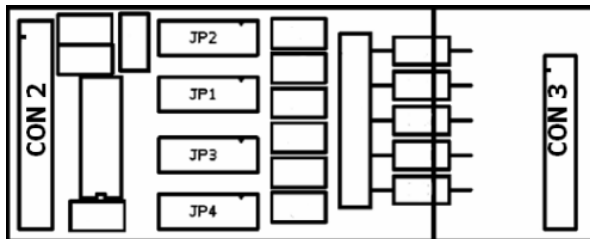

Figure 3.27: [FLEX107] Details of FLEX Multibus SPI Module

Jumper	pos. 1-2	pos. 2-3
JP1	SPI_DO	GND
JP2	SPI_CLK	GND
JP3	SPI_DO_C	GND
JP4	SPI_SS	GND

Note: Default jumper settings are indicated by a •

Table 3.40: FLEX107 - Jumpers

Pin 1	+5V
Pin 2	SPI_DO
Pin 3	SPI_DI
Pin 4	SPI_CLK
Pin 5	SPI_SS
Pin 6	GND

Table 3.41: FLEX107 - CON2

Pin 1	SPI_DO_C
Pin 2	SPI_DI_C
Pin 3	SPI_CLK_C
Pin 4	SPI_SS_C
Pin 5	GND

Table 3.42: FLEX107 - CON3

3.3.9 [FLEX108] FLEX Multibus Serial TTL Module

The board, depicted in Figure 3.28, is the Serial TTL Module. It fits on slot 1 and/or slot 2 of the FLEX Multibus Base Daughter Board, refer Figure 3.14.

This module can be used to export the UART pins linked to the UART peripherals on the dsPIC® by using signals which are compatible with TTL electronic equipments. The module also has a set of components which are used to protect the microcontroller pins from input signals which are not compatible with the specifications.

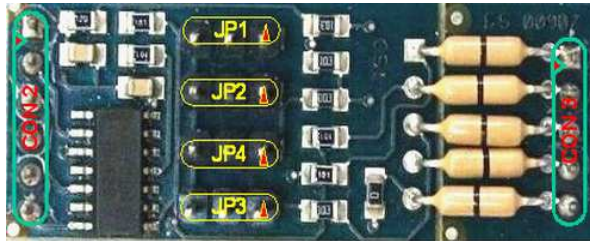

Figure 3.28: [FLEX108] FLEX Multibus Serial TTL Module

3.3.9.1 Technical details

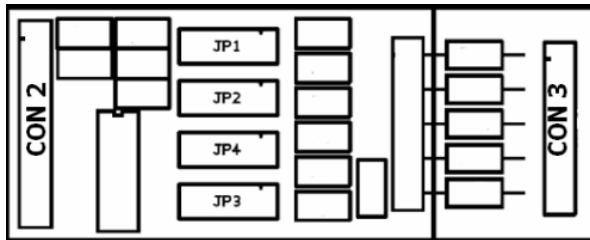

Figure 3.29: [FLEX108] Details of FLEX Multibus Serial TTL Module

Jumper	pos. 1-2	pos. 2-3
JP1	TX_1	GND
JP2	SCK_1	GND
JP3	TX_TTL	GND
JP4	RTS_TTL	GND

Note: Default jumper settings are indicated by a •

Table 3.43: FLEX108 - Jumpers

Pin 1	+5V
Pin 2	TX_1
Pin 3	SCK_1
Pin 4	RX_1
Pin 5	FRCK_1
Pin 6	GND

Table 3.44: FLEX108 - CON2

Pin 1	CTS_TTL
Pin 2	RX_TTL
Pin 3	TX_TTL
Pin 4	RTS_TTL
Pin 5	GND

Table 3.45: FLEX108 - CON3

3.3.10 Multibus I2C Module

The I2C Module fits on slot 5 of the FLEX Multibus Base Daughter Board, refer [Figure 3.14](#).

This module can be used to connect in a safe way an I2C bus to one of the I2C peripherals of the dsPIC®. The protection includes protection from spikes, as well as hot insertions and hot extractions.

3.3.11 [FLEX109] FLEX Demo Daughter Board

The FLEX Demo Board, as depicted in Figures 3.30 and 3.31, is a FLEX Daughter Board, refer Section 3.3, targeted specifically for educational institutions e.g. Schools and Universities.

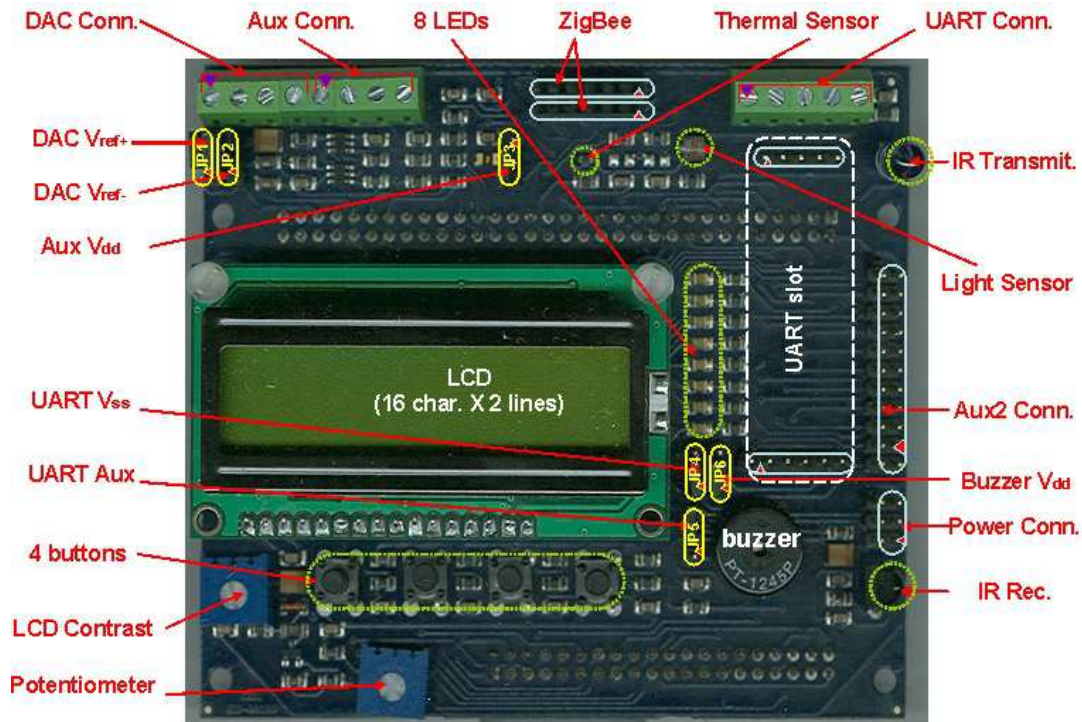

Figure 3.30: [FLEX109] FLEX Demo Daughter Board - front side

The FLEX Demo Board fits directly on FLEX Base Boards (FLEX Full, refer Subsection 3.2.1/FLEX Light, refer Subsection 3.2.2) and it adds-on a lot of most commonly used features that are used for carrying out prototyping and laboratory experiments.

The features hosted on Demo Board are:

- 2 DAC outputs (12 bit resolution)
- 3-axis accelerometer (selectable range from 1.5g to 6g)
- Direct support for quadrature encoder
- Set of 4 Push buttons

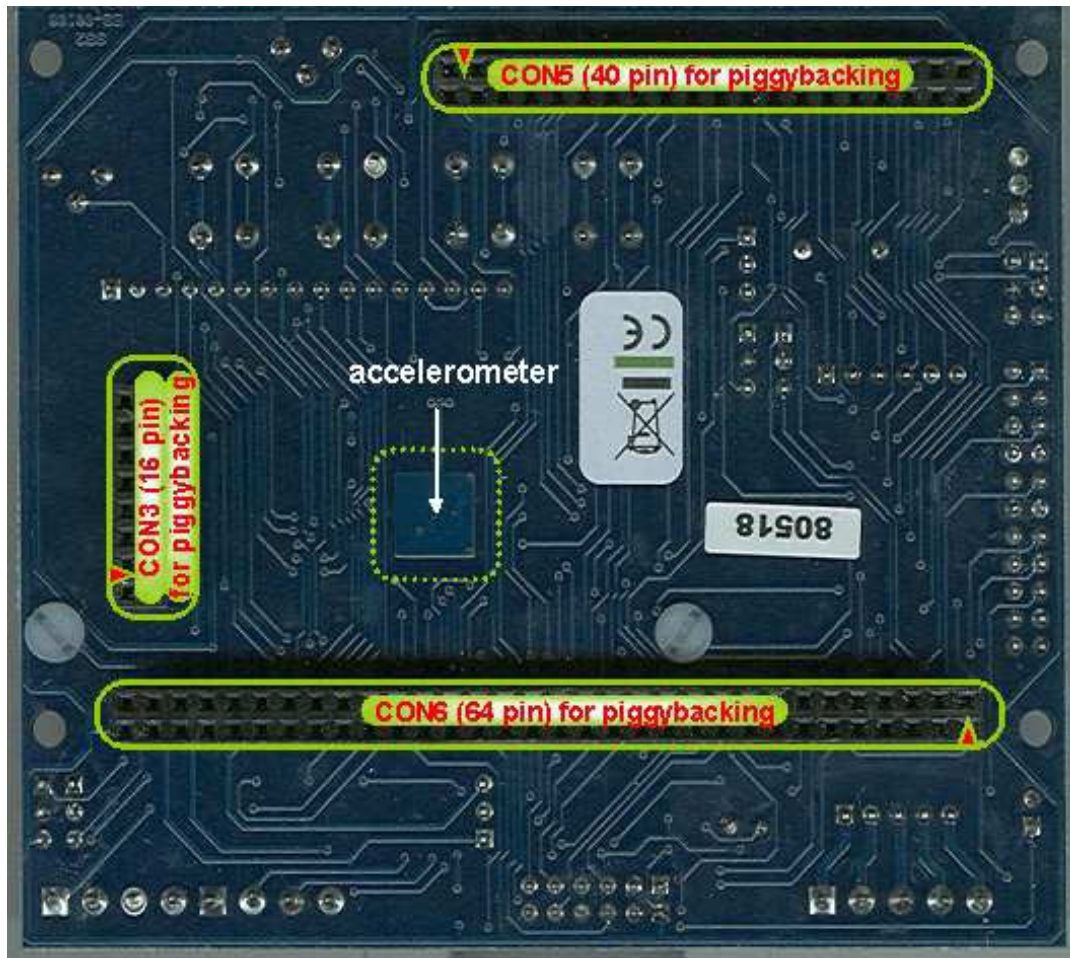

Figure 3.31: [FLEX109] FLEX Demo Daughter Board - back side

- Set of 8 LEDs
- LCD (16 characters x 2 lines)
- Buzzer
- Potentiometer
- Thermal sensor
- Light sensor
- InfraRed receiver and transmitter
- ZigBee connector

- Socket for Multibus serial modules (one of FLEX103, FLEX104, FLEX105, and FLEX108)
- USB wiring for FLEX Full Base Board

Note: The FLEX Demo Board is fully supported by Scilab/Scicos code generator, where specific blocks are available to directly control the main peripherals. Hence, applications can be entirely generated without writing any C code!

3.3.11.1 Technical details

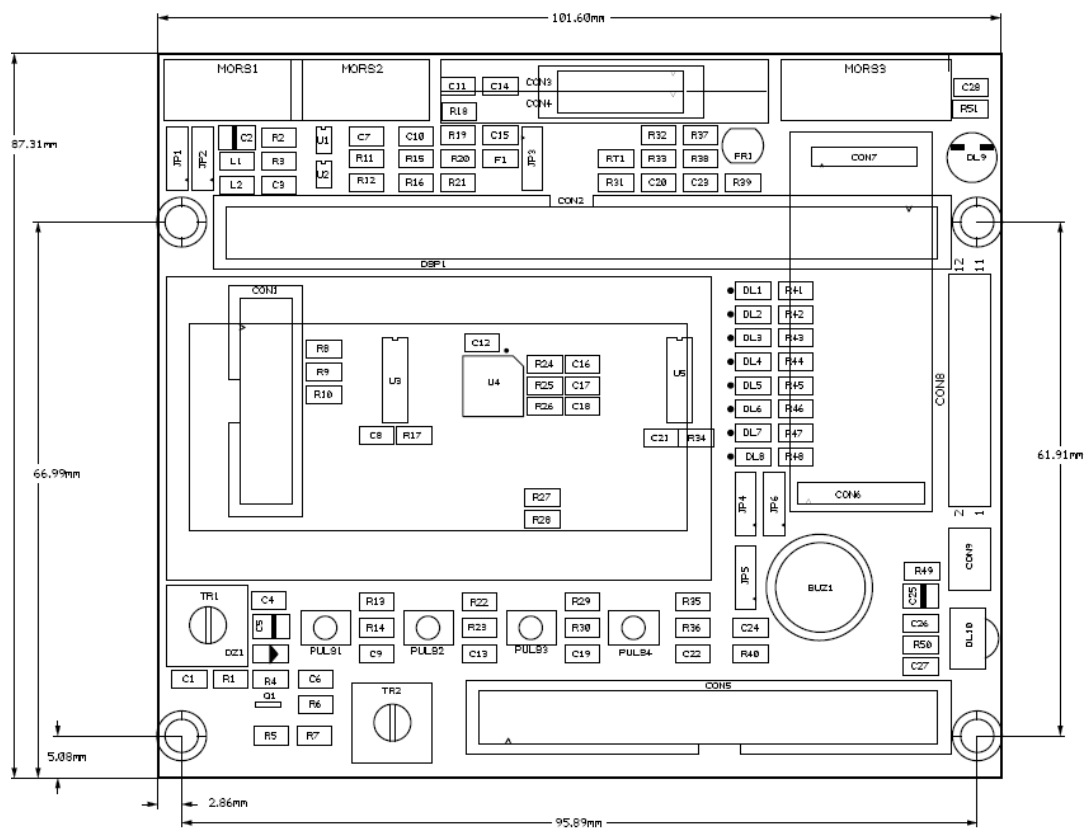

Figure 3.32: [FLEX109] Dimensions of FLEX Demo Daughter Board

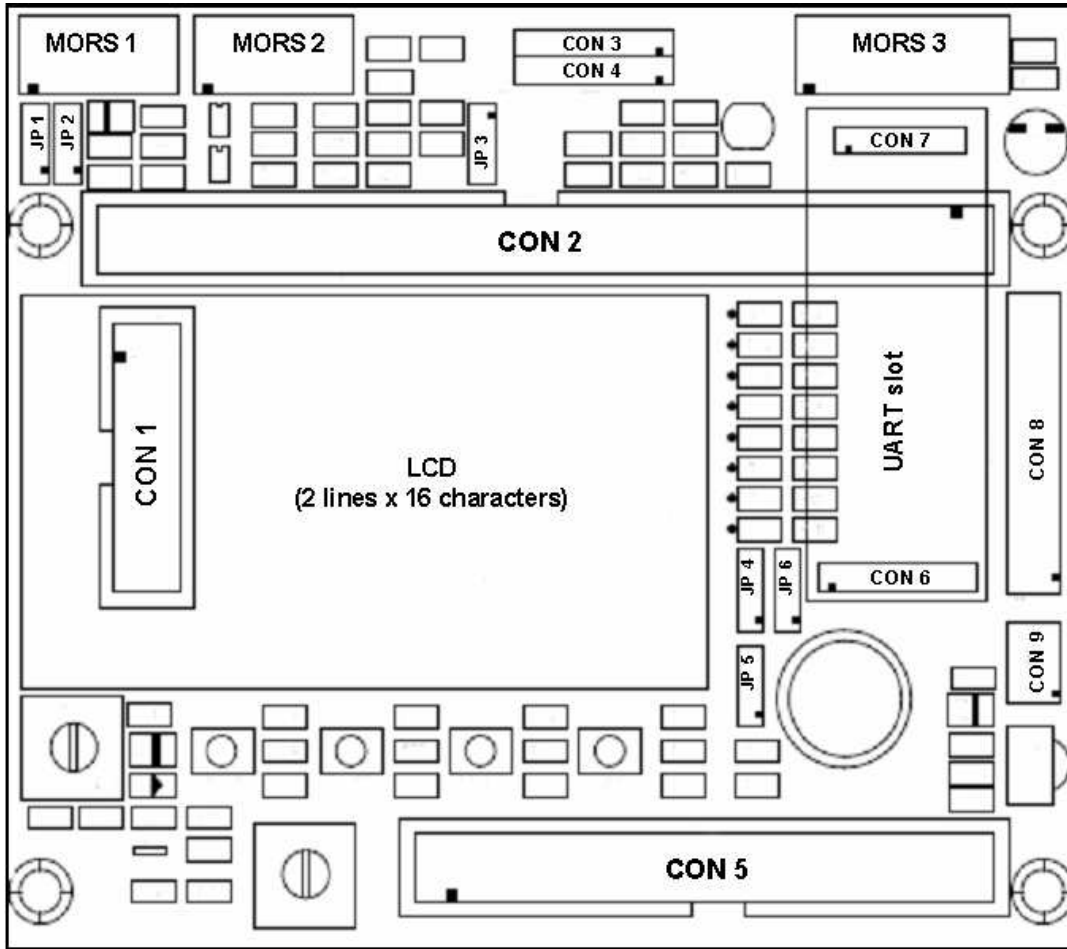

Figure 3.33: [FLEX109] Details of FLEX Demo Daughter Board

Pin 1	Analog Output 1
Pin 2	GND
Pin 3	Analog Output 2
Pin 4	GND

Table 3.46: FLEX109 - MORS1 (DAC Connector)

Pin 1	Data 1
Pin 2	Data 2
Pin 3	Vout/+5V (selectable)
Pin 4	GND

Table 3.47: FLEX109 - MORS2 (AUX Connector)

Pin 1	CTS (232/TTL)/TX+ (422)
Pin 2	RX (232/TTL)/TX- (422)/485- (485)
Pin 3	TX (232/TTL)/RX+ (422)/485+ (485)
Pin 4	RTS (232/TTL)/RX- (422)
Pin 5	GND

Table 3.48: FLEX109 - MORS3 (UART Connector)

DL1 (yellow)	RF0
DL2 (yellow)	RF1
DL3 (yellow)	RF2
DL4 (yellow)	RF3
DL5 (yellow)	RD8
DL6 (yellow)	RD9
DL7 (yellow)	RD10
DL8 (yellow)	RD11

Table 3.49: FLEX109 - LEDs

Jumper	pos. 1-2	pos. 2-3
[JP1] DAC Vref+	• +5V	+3.3V
[JP2] DAC Vref-	• GND	GNDout
[JP3] Aux Vdd	• Vout	+5V
[JP4] UART Vss	• GND	GNDout
[JP5] UART Aux	INT (Konnex/EIB)	• RTS (232/422/TTL)
[JP6] Buzzer Vdd	• Vout	+5V

Note: Default jumper settings are indicated by a •

Table 3.50: FLEX109 - Jumpers

Push Btn.	pin	pos. 1-2 (normal)	pos. 2-3 (pressed)
PULS1	RD4	+5V	GND
PULS2	RD5	+5V	GND
PULS3	RD6	+5V	GND
PULS4	RD15	+5V	GND

Table 3.51: FLEX109 - Push Buttons

CON3		CON4	
Pin 1	+3.3V	Pin 1	GND
Pin 2	Reset	Pin 2	Vreg
Pin 3	FIFO	Pin 3	CSN
Pin 4	SDO	Pin 4	SDI
Pin 5	SCK	Pin 5	CCA
Pin 6	SFD	Pin 6	FIFOP

Table 3.52: FLEX109 - CON3+CON4 (ZigBee Connector)

Pin 1	+5V
Pin 2	RF5 (TX1)
Pin 3	RF12 (SCK1)
Pin 4	RF4 (RX1)
Pin 5	JP6 (default pos. 1-2 i.e. Vout)
Pin 6	JP4 (default pos. 2.3 i.e. GND)

Table 3.53: FLEX109 - CON6 (Connected to Serial TTL)

Pin 1	CTS (232/TTL)/TX+ (422)
Pin 2	RX (232/TTL)/TX- (422)/485- (485)
Pin 3	TX (232/TTL)/RX+ (422)/485+ (485)
Pin 4	RTS (232/TTL)/RX- (422)
Pin 5	GND

Table 3.54: FLEX109 - CON7 (connected to MORS3)

Pin 1	Encoder Index	Pin 2	PWMout 1L
Pin 3	Encoder Channel A	Pin 4	PWMout 1H
Pin 5	Encoder Channel B	Pin 6	PWMout 2L
Pin 7	OC8	Pin 8	PWMout 2H
Pin 9	Analog Input 19	Pin 10	PWMout 3L
Pin 11	OC3	Pin 12	PWMout 3H
Pin 13	DSPPCLK	Pin 14	PWMout 4L
Pin 15	DSPPDATA	Pin 16	PWMout 4H
Pin 17	DSPMCLR	Pin 18	Analog Input 20
Pin 19	AV SSext	Pin 20	Analog Input 21
Pin 21	AV DDext	Pin 22	GND

Table 3.55: FLEX109 - CON8 (AUX2 Connector)

Pin 1	Vout
Pin 2	GNDout
Pin 3	+5V
Pin 4	GND
Pin 5	+3.3V
Pin 6	GND

Table 3.56: FLEX109 - CON9 (Power Connector)

3.4 Packs

3.4.1 [FLEX110] FLEX multibus pack

The FLEX multibus pack, depicted in the Figure 3.34, with most widely used serial communication standards is now available!

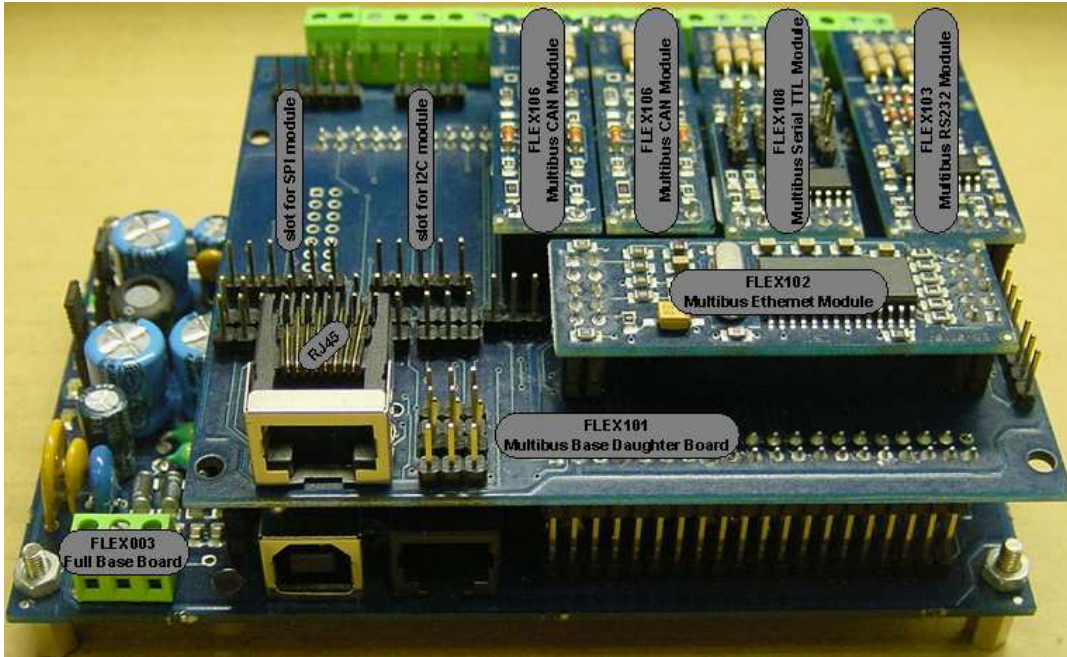

Figure 3.34: [FLEX110] FLEX multibus pack

The FLEX Multibus Base Daughter Board is piggybacked on FLEX Base Boards (FLEX Full, refer Subsection 3.2.1/FLEX Light refer Subsection 3.2.2) and in turn, the FLEX Multibus modules are piggybacked on the FLEX Multibus Base Daughter Board.

The FLEX multibus pack consists of:

- 1 x [FLEX101] FLEX Multibus Base Daughter Board (bare board without Ethernet port), refer Subsection 3.3.2
- 1 x [FLEX102] FLEX Multibus Ethernet Module + 1 x RJ45 Ethernet port (to be soldered), refer Subsection 3.3.3
- 2 x [FLEX103] FLEX Multibus RS232 Modules, refer Subsection 3.3.4

- 1 x [FLEX104] FLEX Multibus RS485 Module, refer Subsection [3.3.5](#)
- 1 x [FLEX105] FLEX Multibus RS422 Module, refer Subsection [3.3.6](#)
- 2 x [FLEX106] FLEX Multibus CAN Modules, refer Subsection [3.3.7](#)
- 1 x [FLEX107] FLEX Multibus SPI Module, refer Subsection [3.3.8](#)
- 1 x [FLEX108] FLEX Multibus Serial TTL Module, refer Subsection [3.3.9](#)

Note: The FLEX multibus pack does not include FLEX Base Board.

3.4.1.1 Technical details

Refer technical details of:

- [FLEX101] FLEX Multibus Base Daughter Board, refer Sub-subsection [3.3.2.1](#)
- [FLEX102] FLEX Multibus Ethernet Module, refer Sub-subsection [3.3.3.1](#)
- [FLEX103] FLEX Multibus RS232 Module, refer Sub-subsection [3.3.4.1](#)
- [FLEX104] FLEX Multibus RS485 Module, refer Sub-subsection [3.3.5.1](#)
- [FLEX105] FLEX Multibus RS422 Module, refer Sub-subsection [3.3.6.1](#)
- [FLEX106] FLEX Multibus CAN Modules, refer Sub-subsection [3.3.7.1](#)
- [FLEX107] FLEX Multibus SPI Module, refer Sub-subsection [3.3.8.1](#)
- [FLEX108] FLEX Multibus Serial TTL Module, refer Sub-subsection [3.3.9.1](#)

3.4.2 [FLEX111] FLEX fast track suite

FLEX boards enable easy and fast development of embedded applications for the Microchip dsPIC® DSC micro-controller. The easily expandable hardware, combined with widely available software applications, makes FLEX ideal for Schools and Universities for fast track education.

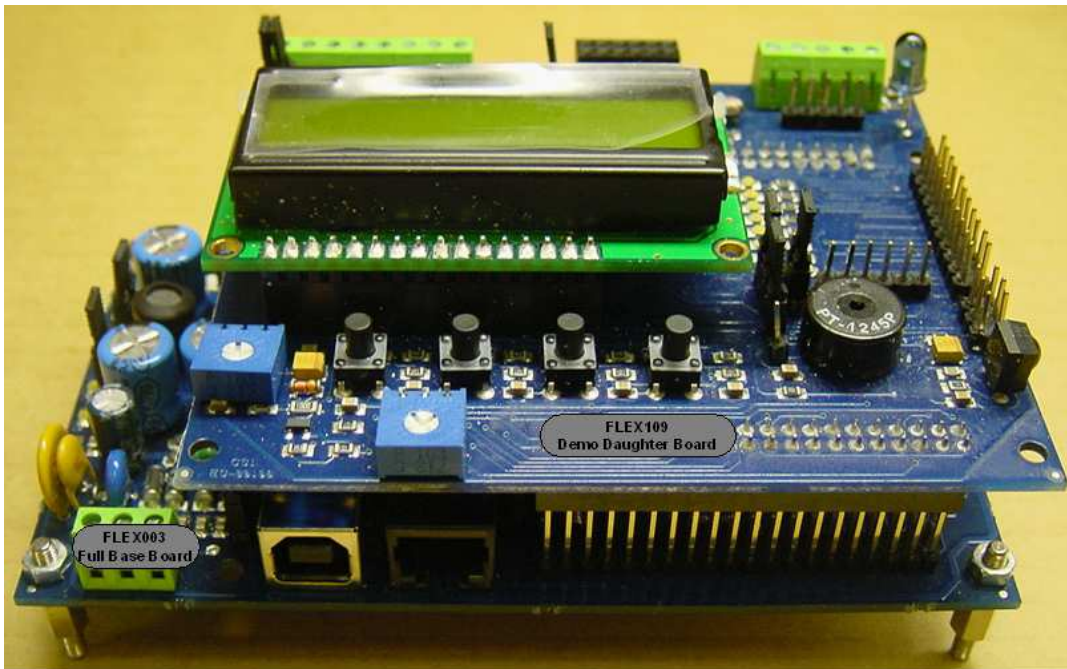

Figure 3.35: [FLEX111] FLEX fast track suite

As depicted in the Figure 3.35, the FLEX Demo Daughter Board is one of the few educational boards offering 2 DAC outputs, a 3-axis accelerometer, and a direct support for an encoder. Moreover, with the direct support of the Scilab code generator, applications can be entirely generated without writing any C code.

The FLEX fast track suite consists of:

- Hardware
 - 1 x [FLEX003] FLEX Full Base Board, refer Subsection 3.2.2
 - 1 x [FLEX109] FLEX Demo Daughter Board, refer Subsection 3.3.11
- Free Software

- ERIKA Enterprise real-time kernel
- Scilab/Scicos simulation and code generation tool
- Support (available on the web-site)
 - Ready to run demos with source code
 - Application notes
 - User Forums
 - Wiki

3.4.2.1 Technical details

Refer technical details of:

- [FLEX003] FLEX Full Base Board, refer Sub-subsection [3.2.2.1](#)
- [FLEX109] FLEX Demo Daughter Board, refer Sub-subsection [3.3.11.1](#)

3.5 Hardware Customisation

A number of possible extensions can be made to the FLEX Base Boards, refer Section [3.2](#), to add new functionalities, sensors, network connections, actuators, etc. Simple extensions can be made by hand by either using a Thru Hole Board, refer Subsection [3.3.1](#), or using a Multibus Base Board, refer Subsection [3.3.2](#). More decent extensions may require some expertise. This may require some special equipment (e.g. mounting SMD components) to implement a fully functional board. To avoid these problems, Embedded Solutions Srl can handle you specific needs and create a customised Daughter Board for FLEX, refer Section [3.3](#).

Depending on the number of items to be produced, it could be convenient to re-engineer an entire board together with the Base and the Daughter Boards to save on size, weight, and power consumption. Embedded Solutions also handles prototyping of multilayer boards with SMT and PTH technologies.

Contact us for customised FLEX Daughter Boards!

4 Software for FLEX

The FLEX boards comes with a rich software infrastructure which symplifies the appli-cation development.

4.1 Erika Enterprise

First of all, FLEX comes with Erika Enterprise as the default software development envi-ronment. In particular, Erika Enterprise for Microchip dsPIC (R) DSC micro-controller family is a complete open-source¹ RTOS implementing the OS, OIL, and ORTI part of the OSEK/VDX standard (<http://www.osek-vdx.org>). Erika Enterprise includes the state of the art real- time technology as well as the RT-Druid configuration tool, which allows easy design and optimization of a real-time application.

4.2 Libraries for FLEX

Erika Enterprise fully supports the FLEX boards and all the Daughter Boards. A complete set of libraries allows the exploitation of all the features provided. The development of complex applications based on the FLEX Base Board and available Daughter Boards is simplified by a well documented and clear set of primitives. The needed libraries can be configured using the RT-Druid tool, letting the developer to dedicate the efforts to the implementation of the program logic.

4.3 Template applications

A set of template applications using the FLEX boards are also available. These applica-tions can be instantiated as RT-Druid projects by selecting the appropriate template at project creation time.

¹Erika Enterprise is distributed under the GPL+Linking exception license

4.4 Scilab and Scicos code generator

Finally, a code generator for Scilab and Scicos designs is also available. The code generator has been developed in collaboration with Simone Mannori from INRIA (FR), and Roberto Bucher from SUPSI Lugano.

Please check the Evidence web site <http://erika.tuxfamily.org> to get updated documentation and manuals about the Scilab/Scicos code generator support.

5 FLEX Producers and Distributors

5.1 FLEX Producers



The FLEX platform is a result of synergistic effort of two Italian companies working in the field of embedded systems: Evidence Srl and Embedded Solutions. These two companies combined their respective skills on real-time systems and electronic boards development, to create this complete, easy-to-use, compact solution for creating complex applications based on the Microchip dsPIC® DSC micro-controller.

In particular,

- Evidence Srl provided a GPL version of the Erika Enterprise RTOS, including template applications for the FLEX Boards.
- Embedded Solutions Srl provided the hardware design and is also the producer of the FLEX hardware.

In addition to the availability of a set of Daughter Boards, it is also possible to make customised Daughter Boards. If you are interested in having customised FLEX hardware, please check Section [3.5](#).

5.2 FLEX Distributors

FLEX Boards are only sold through distributors.

Please refer to the distributors list, Table 5.1, to buy FLEX Boards!

5.2.1 Where is FLEX available?

Location	Distributor
<i>Europe:</i>	
Italy	EMCElettronica http://dev.emcelettronica.com/
Italy	InWare srl http://www.elettroshop.it/
France	M.N.I.S. http://www.mnis.fr/
UK	Farnell http://www.farnell.co.uk/
<i>Asia:</i>	
Japan	IPIShop http://www.ipishop.com/
<i>USA:</i>	
USA	Microcontroller Shop http://microcontrollershop.com/
USA	Spark Fun Electronics Inc. http://www.sparkfun.com/
<i>South America:</i>	
Chile & South America	Ingeniería MCI Ltda. (Olimex Chile) http://www.olimex.cl/
<i>Worldwide:</i>	
Worldwide	Farnell http://www.farnell.com/
Worldwide	Microchip Direct http://www.microchipdirect.com/

Table 5.1: FLEX Distributors

5.2.2 What if my country is not listed?

Please select the nearest distributor to your site!

5.2.3 Would you like to become a distributor?

If you are a distributor and you want to distribute FLEX Boards in selected countries, please do not hesitate to contact us!